

A black and white photograph featuring a lamp base on the left and a bouquet of dried flowers on the right, both resting on a wooden surface. The lamp base is a multi-tiered, metallic structure with a textured, dark middle section. The bouquet consists of several dried, curled flower heads. The background is a soft, out-of-focus light gray.

seTup.lighting
VISIBLE EMOTIONS



C O M P A N Y

INTRODUCTION

Setup.lighting is a manufacture which design, develop and produce unique solutions made of wood, metal and innovative LED technology.

We see us as an engineering and production platform for designers and architects with the ability to realise customised solutions based on various materials, especially natural materials, within a few weeks.

As a team of designers, thinkers, collaborators and problem solvers, with over two decades of experience, we're able to offer a wide-range of services; machining dozens of different materials, from the everyday to the exotic, high-end finishing and complex installations.



MANUFACTURE FOR WOOD, METAL AND LIGHT





WOOD LINEAR LED 60 2R

Wood Linear LED 2R is a minimalistic wood luminaire with integrated LED driver. The optical system can be equipped with innovative dark light reflectors or with milled light chambers in different designs. The length can be customized to realize continuous line system.

Surface treatments: Natural, oiled, antibacterial coating with silver nanoparticles (flame retardant according to DIN 4102 B1)



WOOD LINEAR LED 60 PURE

Wood Linear LED 60 PURE is a minimalistic wood luminaire with a width of just 60mm and a height of 28mm. The optical systems combine lenses with milled light chambers. Since the light emitting surface is continuous, the driver needs to be placed on or inside the ceiling.

Surface treatments: Natural, oiled, antibacterial coating with silver nanoparticles (flame retardant according to DIN 4102 B1)



WOOD LINEAR 70 LED

Wood Linear LED 70 is a direct and indirect emitting LED luminaire with integrated LED driver. The optical system can be equipped with innovative dark light reflectors or with milled light chambers in different designs. The very wide indirect light distribution provides a soft ceiling illumination.

Surface treatments: Natural, oiled, antibacterial coating with silver nanoparticles (flame retardant according to DIN 4102 B1)



WOOD WAVE LED 120

Wood Wave LED 120 is a very special linear solid wood luminaire with direct and indirect illumination. The direct light is emitted through high precision lenses and milled light chambers which create a rectangular light footprint on the illumination surface for highest light uniformity. The advantage of this unique optical solution is the night effect of the illuminated wood texture. The same result is achieved on the wave shape due to the reflected light from the ceiling which is highlighting the wood texture on the luminaire top. Due to the wave shape this illuminated wood texture is visible from the side view as well. This effect is very unique and a new concept in our designs to convert the luminaire to a design element during times when daylight is not present anymore.

Surface treatments: Natural, oiled, antibacterial coating with silver nanoparticles (flame retardant according to DIN 4102 B1)



WOOD LINEAR 60 LED TWIN ROUND

Wood Linear 60 LED Twin Round is a stylish luminaire with integrated LED driver. The optical system can be equipped with innovative dark light reflectors or with milled light chambers in different designs. The shape is perfectly suitable for acoustic absorber integration or natural materials.

Surface treatments: Natural, oiled, antibacterial coating with silver nanoparticles (flame retardant according to DIN 4102 B1)

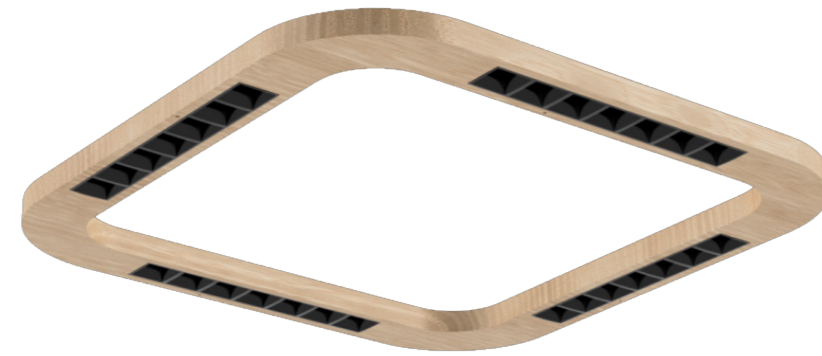

WOOD SQUARE LED 60-600

Wood Square LED 60 is a direct or direct/indirect emitting LED luminaire in square shape. The driver is placed on or inside the ceiling. The optical system can be equipped with innovative dark light reflectors or with milled light chambers in different designs. The shape is ideal for integration of acoustic absorber or natural material fill-ins.

Surface treatments: Natural, oiled, antibacterial coating with silver nanoparticles (flame retardant according to DIN 4102 B1)



WOOD RING LED 70-700

Wood Ring LED 70 is a round LED luminaire. The optical systems is based lenses, positioned around the circle. The LED driver is integrated. The shape is ideal for integration of acoustic absorber or natural material fill-ins.

Surface treatments: Natural, oiled, antibacterial coating with silver nanoparticles (flame retardant according to DIN 4102 B1)

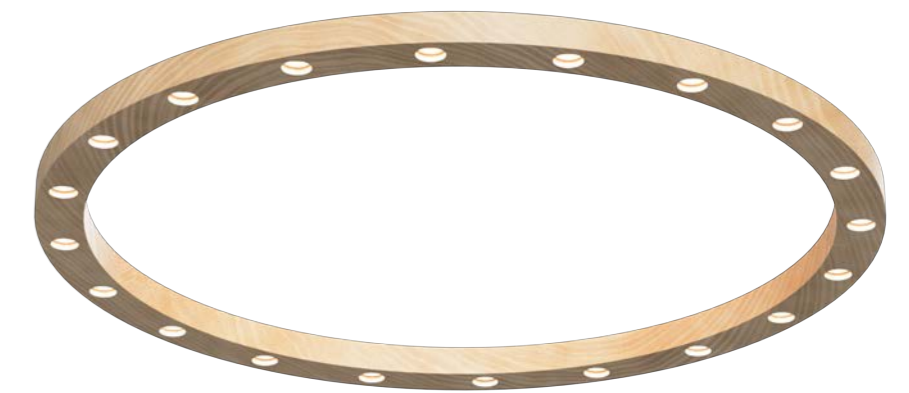

WOOD RING LED 70-1200

Wood Ring LED 70 is a round LED luminaire. The optical systems is based lenses, positioned around the circle. The LED driver is integrated. The shape is ideal for integration of acoustic absorber or natural material fill-ins.

Surface treatments: Natural, oiled, antibacterial coating with silver nanoparticles (flame retardant according to DIN 4102 B1)



WOOD WALL LED

Wood Wall LED is an up and down light emitting wall mounted LED luminaire made of solid wood. Various beam angles make it easy to highlight pillars and set the right accentuation.

Surface treatments: Natural, oiled, antibacterial coating with silver nanoparticles (flame retardant according to DIN 4102 B1)



WOOD TRIANGLE LED

Wood Triangle LED is the perfect luminaire for night illumination usually mounted above the doors. The length can be customized. Another application is the use as wall luminaire with indirect light distribution. The driver is integrated.

Surface treatments: Natural, oiled, antibacterial coating with silver nanoparticles (flame retardant according to DIN 4102 B1)



WOOD FREESTANDING LED

Wood Freestanding LED is one of the view freestanding luminaire based on solid wood. The indirect light distribution is very wide. The optical system can be equipped with innovative dark light reflectors or with milled light chambers in different designs. The integrated daylight and movement sensor provides best energy efficiency characteristics.

Surface treatments: Natural, oiled, antibacterial coating with silver nanoparticles (flame retardant according to DIN 4102 B1)



L I N E A R 6 0 2 R

DATASHEET



PRODUCT DATA

Size : 1170 x 60 x 28 mm
 Weight : 1,2 kg
 Materials : Housing : Natural solid wood
 Optic: Polycarbonate lens + reflector
 Base plate: Aluminium
 Optic : Dark Light Reflector 80°
 Light distribution : Direct
 Driver : FIX, DALI, Bluetooth (build in)
 Ambient temperature : 0 / + 35 °C
 Lifetime : L80B10 - 60 000 hours
 Installation : suspended

WOOD LINEAR LED 60 2R



WOOD OPTIONS

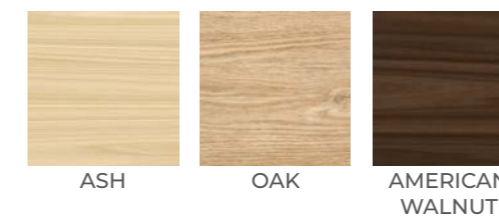

TECHNICAL SPECIFICATION

CODE	POWER	CRI	CCT	LUMEN
WL602R	27 W	> 90	3000 K	3480 lm
WL602R	27 W	> 90	4000 K	3630 lm
WL602R	28 W	> 90	TW (2700 - 6500 K)	3480 lm

Order example:

WL602R	-	Power	-	CRI / CCT	-	Beam	-	Wood	-	Driver	-	Option
WL602R	-	27	-	930	-	80	-	OAK	-	FIX	-	XYZ



L I N E A R P U R E 6 0

DATASHEET



PRODUCT DATA

Size : 1170 x 60 x 25 mm
 Weight : 1,3 kg
 Materials : Housing: Natural solid wood
 Optic: Polycarbonate lens
 Base plate: Aluminium
 Optic : Lens and milled optic chamber 80°
 Light distribution : Direct
 Driver : FIX, DALI, Bluetooth (inside or on ceiling)
 Ambient temperature : 0 / + 35 °C
 Lifetime : L80B10 - 60 000 hours
 Installation : suspended

WOOD LINEAR LED 60 PURE

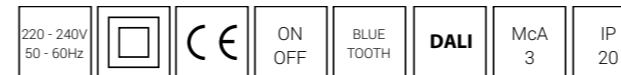

WOOD OPTIONS

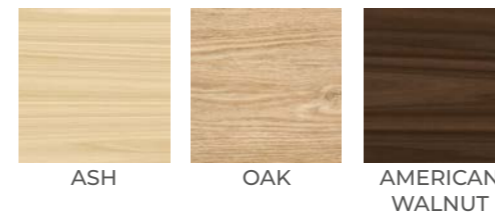

TECHNICAL SPECIFICATION

CODE	POWER	CRI	CCT	LUMEN
WL60P	27 W	> 90	3000 K	3480 lm
WL60P	27 W	> 90	4000 K	3630 lm
WL60P	28 W	> 90	TW (2700 - 6500 K)	3480 lm

Order example:

WL60P	-	Power	-	CRI / CCT	-	Beam	-	Wood	-	Driver	-	Option
WL60P	-	27	-	930	-	80	-	OAK	-	FIX	-	XYZ



L I N E A R P U R E 9 3 0

DATASHEET

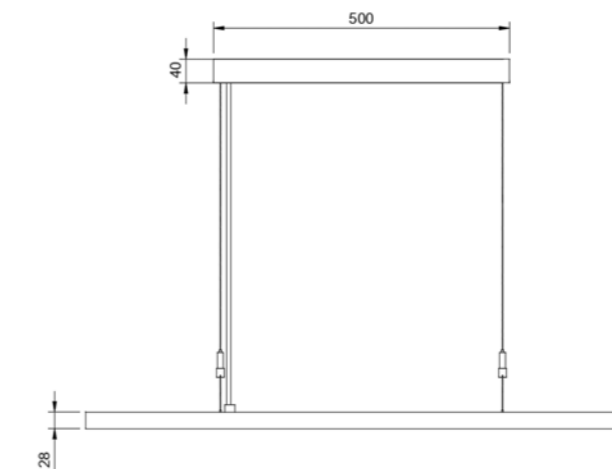
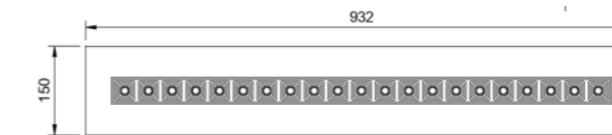

PRODUCT DATA

Size: 932 x 150 x 28
 Weight: 4,2 kg
 Materials : Housing: Natural solid wood
 Optic: Polycarbonate lens
 Base plate: Aluminium
 Optic : Lens and milled optic chamber 80°
 Light distribution : Direct
 Driver : FIX, DALI, Bluetooth (inside or on ceiling)
 Ambient temperature : 0 / + 35 °C
 Lifetime : L80B10 - 60 000 hours
 Installation : suspended

WOOD LINEAR LED 150x930 PURE

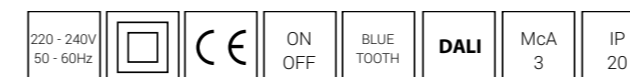

WOOD OPTIONS

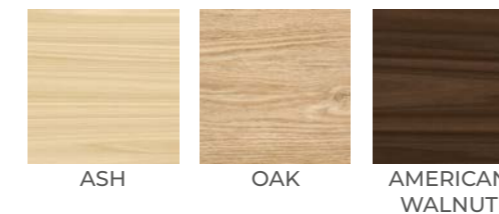

TECHNICAL SPECIFICATION

CODE	POWER	CRI	CCT	LUMEN
WL150x930P	27 W	> 90	2700 K	2768 lm
WL150x930P	27 W	> 90	3000 K	2761 lm
WL150x930P	27 W	> 90	4000 K	2961 lm
WL150x930P	27 W	> 90	TW (2700 - 6500 K)	2768 lm

Order example:

WL150x930P	-	Power	-	CRI / CCT	-	Beam	-	Wood	-	Driver	-	Option
WL150x930P	-	27	-	930	-	80	-	EICHE	-	On-Off	-	XYZ



L I N E A R P U R E 1 2 2 0

DATASHEET

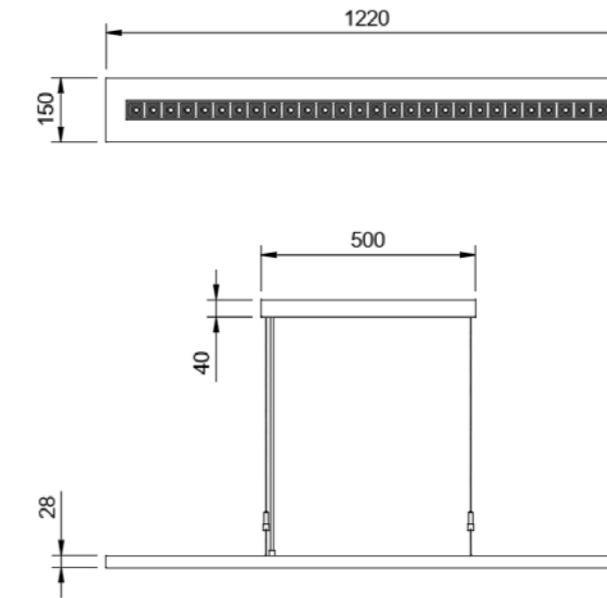

PRODUCT DATA

Size: 1220 x 150 x 28
 Weight: 4,8 kg
 Materials : Housing: Natural solid wood
 Optic: Polycarbonate lens
 Base plate: Aluminium
 Optic : Lens and milled optic chamber 80°
 Light distribution : Direct
 Driver : FIX, DALI, Bluetooth (inside or on ceiling)
 Ambient temperature : 0 / + 35 °C
 Lifetime : L80B10 - 60 000 hours
 Installation : suspended

WOOD LINEAR LED 150x1220 PURE



WOOD OPTIONS

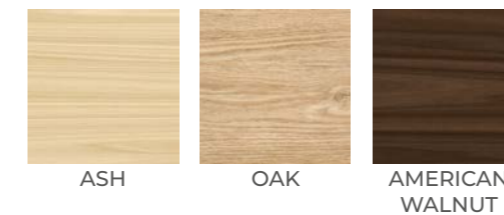

TECHNICAL SPECIFICATION

CODE	POWER	CRI	CCT	LUMEN
WL150x1220P	32 W	> 90	2700 K	3280 lm
WL150x1220P	32 W	> 90	3000 K	3272 lm
WL150x1220P	32 W	> 90	4000 K	3509 lm
WL150x1220P	32 W	> 90	TW (2700 - 6500 K)	3280 lm

Order example:

WL150x1220P	-	Power	-	CRI / CCT	-	Beam	-	Wood	-	Driver	-	Option
WL150x1220P	-	32	-	930	-	80	-	EICHE	-	On-Off	-	XYZ



L I N E A R P U R E 1 5 0 0

DATASHEET

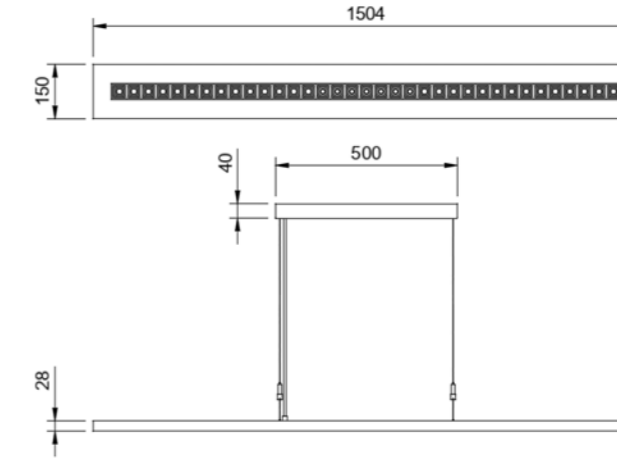
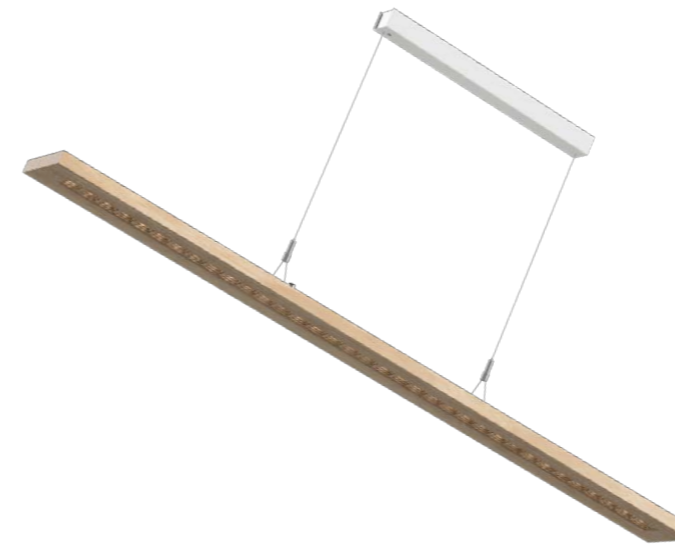

PRODUCT DATA

Size: 1504 x 150 x 28
 Weight: 5,8 kg
 Materials : Housing: Natural solid wood
 Optic: Polycarbonate lens
 Base plate: Aluminium
 Optic : Lens and milled optic chamber 80°
 Light distribution : Direct
 Driver : FIX, DALI, Bluetooth (inside or on ceiling)
 Ambient temperature : 0 / + 35 °C
 Lifetime : L80B10 - 60 000 hours
 Installation : suspended

WOOD LINEAR LED 150x1500 PURE

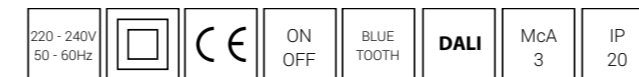

WOOD OPTIONS

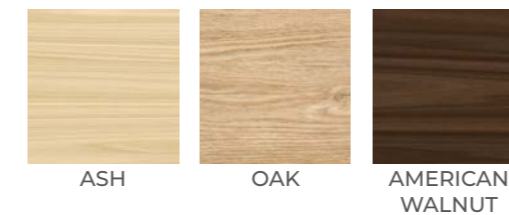

TECHNICAL SPECIFICATION

CODE	POWER	CRI	CCT	LUMEN
WL150x1500P	37 W	> 90	2700 K	3793 lm
WL150x1500P	37 W	> 90	3000 K	3784 lm
WL150x1500P	37 W	> 90	4000 K	4058 lm
WL150x1500P	37 W	> 90	TW (2700 - 6500 K)	3793 lm

Order example:

WL150x1500P	-	Power	-	CRI / CCT	-	Beam	-	Wood	-	Driver	-	Option
WL150x1500P	-	37	-	930	-	80	-	EICHE	-	On-Off	-	XYZ



LINEAR 70

DATASHEET

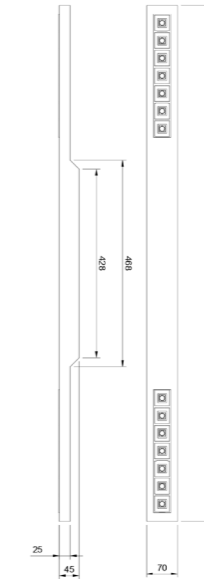

PRODUCT DATA

Size : 1170 x 70 x 45 mm
Weight : 1,9 kg
Materials : Housing : Natural solid wood
 Optic: Polycarbonate lens + reflector
 Back plate: Aluminium
Optic : Dark Light Reflector 80°
Light distribution : Direct 66 % , Indirect 34 %
Driver : FIX, DALI, Bluetooth (build in)
Ambient temperature : 0 / + 35 °C
Lifetime : L80B10 - 60 000 hours
Installation : suspended

WOOD LINEAR 70 LED

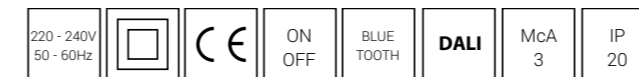

WOOD OPTIONS

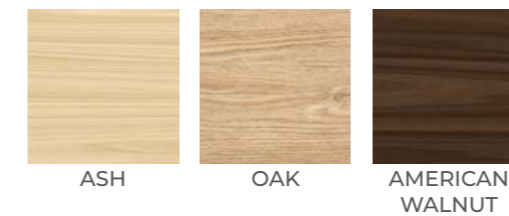

TECHNICAL SPECIFICATION

CODE	POWER	CRI	CCT	LUMEN
WL70DI	32 W	> 90	3000 K	4060 lm
WL70DI	32 W	> 90	4000 K	4230 lm
WL70DI	33 W	> 90	TW (2700 - 6500 K)	3870 lm

Order example:

WL70DI	-	Power	-	CRI / CCT	-	Beam	-	Wood	-	Driver	-	Option
WL70DI	-	32	-	930	-	80	-	OAK	-	FIX	-	XYZ



W A V E 1 2 0

DATASHEET



PRODUCT DATA

Size : 1280 x 120 x 45 mm
Weight : 2,9 kg
Materials : Housing : Natural solid wood
 Optic: Miled light chambers
 Back plate: Black powder coated
 Aluminium 2 mm
Optic : High precision lens + miled light chambers
 80°
Light distribution : Direct 66 % , Indirect 34 %
Driver : FIX, DALI, Bluetooth (inside or on the ceiling)
Ambient temperature : 0 / + 35 °C
Lifetime : L80B10 - 60 000 hours
Installation : suspended
Surface treatment : Natural, oiled, fire-proof coating, anti-bacterial coating

WOOD WAVE LED 120

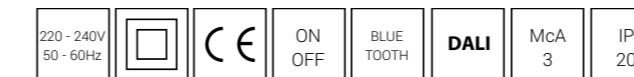

WOOD OPTIONS

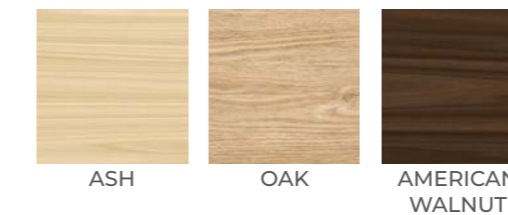

TECHNICAL SPECIFICATION

CODE	POWER	CRI	CCT	LUMEN
WW120P	32 W	> 90	3000 K	4060 lm
WW120P	32 W	> 90	4000 K	4230 lm
WW120P	33 W	> 90	TW (2700 - 6500 K)	4060 lm

Order example:

WW120P	-	Power	-	CRI / CCT	-	Beam	-	Wood	-	Driver	-	Option
WW120P	-	32	-	930	-	80	-	OAK	-	FIX	-	XYZ



TWIN ROUND

DATASHEET

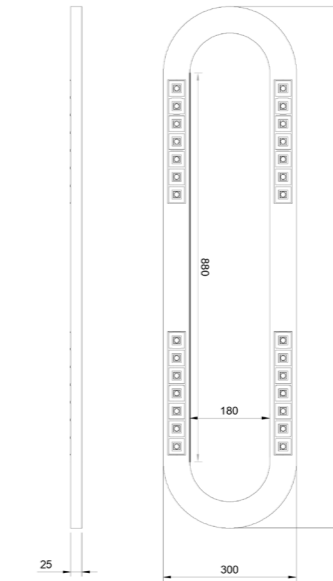

PRODUCT DATA

Size : 1180 x 300 x 25 mm
 Weight : 3,6 kg
 Materials : Housing : Natural solid wood
 Optic: Polycarbonate lens + reflector
 Back plate: Aluminium
 Optic : Dark Light Reflector 80°
 Light distribution : Direct
 Driver : FIX, DALI, Bluetooth (build in)
 Ambient temperature : 0 / + 35 °C
 Lifetime : L80B10 - 60 000 hours
 Installation : suspended

WOOD LINEAR 60 LED TWIN ROUND

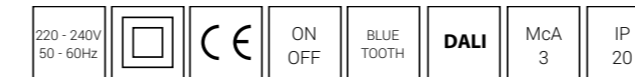

WOOD OPTIONS

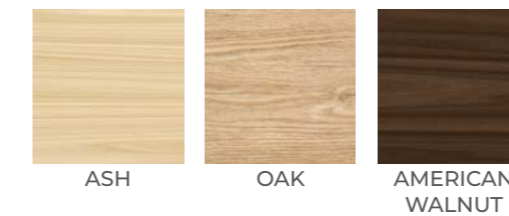

TECHNICAL SPECIFICATION

CODE	POWER	CRI	CCT	LUMEN
WL60TR	27 W	> 90	3000 K	3480 lm
WL60TR	27 W	> 90	4000 K	3630 lm
WL60TR	28 W	> 90	TW (2700 - 6500 K)	3480 lm

Order example:

WL60TR	-	Power	-	CRI / CCT	-	Beam	-	Wood	-	Driver	-	Option
WL60TR	-	27	-	930	-	80	-	OAK	-	FIX	-	XYZ



S Q U A R E

DATASHEET

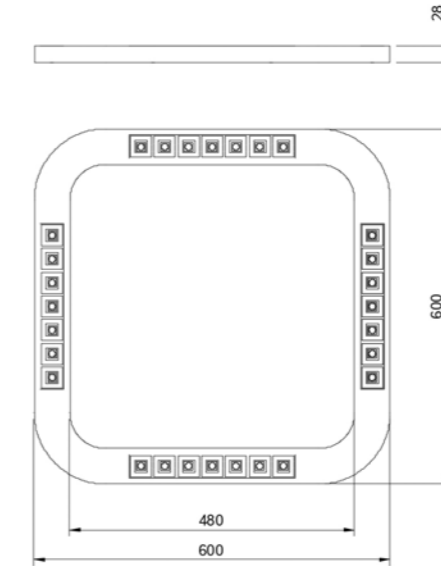

PRODUCT DATA

Size : 600 x 600 x 28 mm
 Weight : 2 kg
 Materials : Housing : Natural solid wood
 Optic: Polycarbonate lens + reflector
 Back plate:: Aluminium
 Optic : Dark Light Reflector 80°
 Light distribution : Direct
 Driver : FIX, DALI, Bluetooth (inside or on ceiling)
 Ambient temperature : 0 / + 35 °C
 Lifetime : L80B10 - 60 000 hours
 Installation : suspended

WOOD SQUARE 60-600 LED

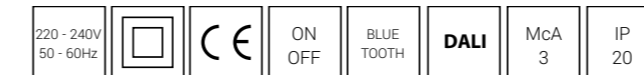

WOOD OPTIONS

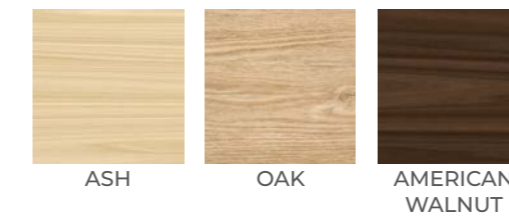

TECHNICAL SPECIFICATION

CODE	POWER	CRI	CCT	LUMEN
WS60-600	27 W	> 90	3000 K	3480 lm
WS60-600	27 W	> 90	4000 K	3630 lm
WS60-600	28 W	> 90	TW (2700 - 6500 K)	3480 lm

Order example:

WS60-600	-	Power	-	CRI / CCT	-	Beam	-	Wood	-	Driver	-	Option
WS60-600	-	27	-	930	-	80	-	OAK	-	FIX	-	XYZ



R I N G 7 0 0

DATASHEET

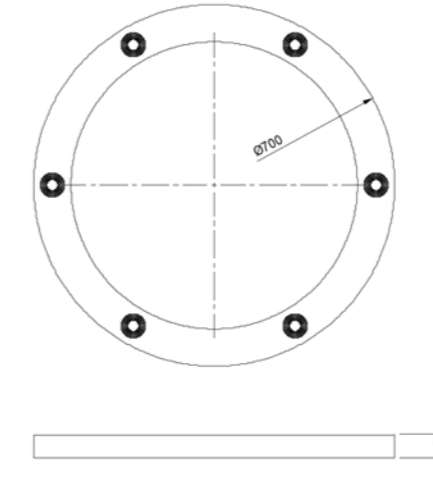

PRODUCT DATA

Size : 700 x 700 x 45 mm
Weight : 3,2 kg
Materials : Housing : Natural solid wood
 Optic: Polycarbonate lens
 Base plate: Aluminium
Optic : Lens 36°, 60° and milled light chambers
Light distribution : Direct
Driver : FIX, DALI, Bluetooth (build in)
Ambient temperature : 0 / + 35 °C
Lifetime : L80B10 - 60 000 hours
Installation : suspended

WOOD RING LED 70-700

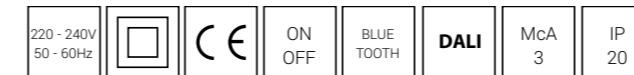

WOOD OPTIONS

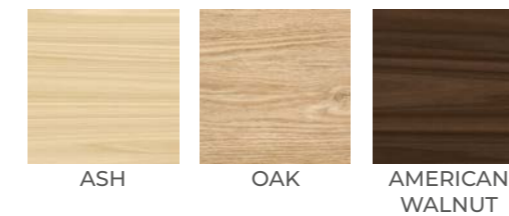

TECHNICAL SPECIFICATION

CODE	POWER	CRI	CCT	LUMEN
WRI70-700	70 W	> 90	3000 K	7800 lm
WRI70-700	70 W	> 90	4000K	8000 lm

Order example:

WRI70-700	-	Power	-	CRI / CCT	-	Beam	-	Wood	-	Driver	-	Option
WRI70-700	-	70	-	930	-	60	-	OAK	-	FIX	-	XYZ



R I N G 1 2 0 0

DATASHEET

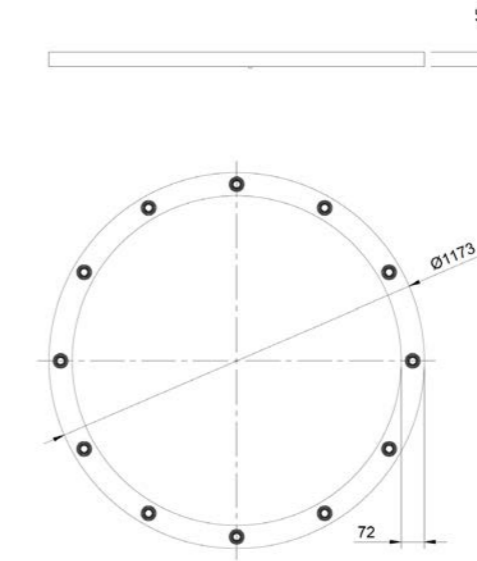

PRODUCT DATA

Size : 1173 x 1173 x 45 mm
 Weight : 6,2 kg
 Materials : Housing : Natural solid wood
 Optic: Polycarbonate lens
 Base plate: Aluminium
 Optic : Lens 36°, 60° and milled light chambers
 Light distribution : Direct
 Driver : FIX, DALI, Bluetooth (build in)
 Ambient temperature : 0 / + 35 °C
 Lifetime : L80B10 - 60 000 hours
 Installation : suspended

WOOD RING LED 70-1200

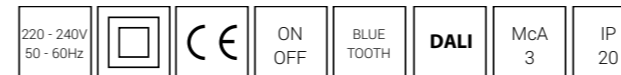

WOOD OPTIONS

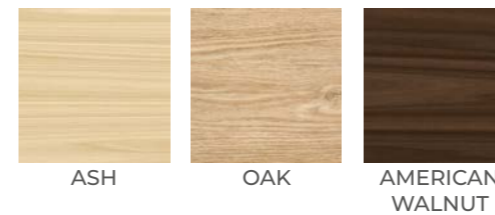

TECHNICAL SPECIFICATION

CODE	POWER	CRI	CCT	LUMEN
WRI70-1200	70 W	> 90	3000 K	7800 lm
WRI70-1200	70 W	> 90	4000K	8000 lm

Order example:

WRI70-1200	-	Power	-	CRI / CCT	-	Beam	-	Wood	-	Driver	-	Option
WRI70-1200	-	70	-	930	-	60	-	OAK	-	FIX	-	XYZ



W O O D W A L L

DATASHEET

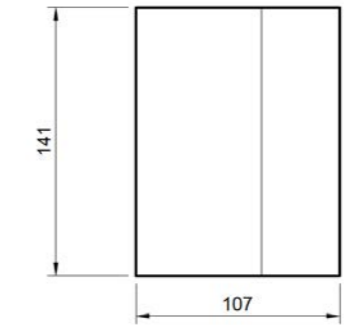
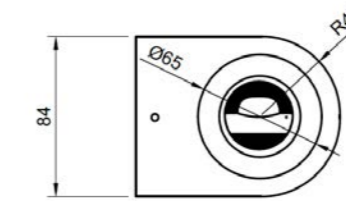

PRODUCT DATA

Size : 107 x 141 x 84 mm
 Weight : 0,8 kg
 Materials : Housing : Natural solid wood
 Optic: Polycarbonate lens
 Base plate: Aluminium
 Optic : Lens 38°, 55° and milled light chambers
 Light distribution : Direct
 Driver : FIX, DALI, Bluetooth (build in)
 Ambient temperature : 0 / + 35 °C
 Lifetime : L80B10 - 60 000 hours
 Installation : wall mounted

WOOD WALL LED



WOOD OPTIONS

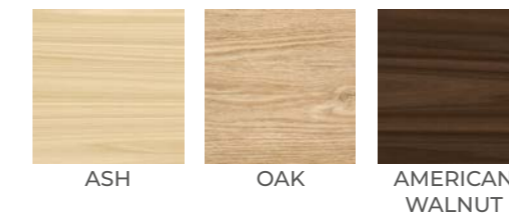

TECHNICAL SPECIFICATION

CODE	POWER	CRI	CCT	LUMEN
WW	7 W	> 90	3000 K	700 lm
WW	7 W	> 90	4000K	700 lm

Order example:

WW	-	Power	-	CRI / CCT	-	Beam	-	Wood	-	Driver	-	Option
WW	-	7	-	930	-	2x55	-	OAK	-	FIX	-	XYZ

DATASHEET



T R I A N G L E



PRODUCT DATA

Size : 990 x 185 x 65 mm
 Weight : 1,8 kg
 Materials : Housing : Natural solid wood
 Optic: PMMA diffusor
 Back plate:: Aluminium
 Optic : PMMA diffusor
 Light distribution : Direct
 Driver : FIX, DALI, Bluetooth (build in)
 Ambient temperature : 0 / + 35 °C
 Lifetime : L80B10 - 60 000 hours
 Installation : surface mounted (wall)

WOOD TRIANGLE LED

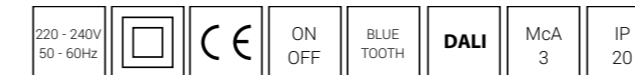

WOOD OPTIONS

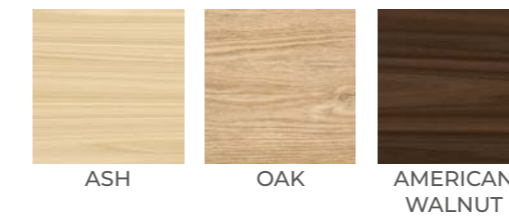

TECHNICAL SPECIFICATION

CODE	POWER	CRI	CCT	LUMEN
WT	24 W	> 90	3000 K	1800 lm
WT	24 W	> 90	4000 K	1890 lm
WT	24 W	> 90	TW (2700 - 6500 K)	1800 lm

Order example:

WT	-	Power	-	CRI / CCT	-	Beam	-	Wood	-	Driver	-	Option
WT	-	24	-	930	-	DIFF	-	ASH	-	FIX	-	XYZ



F R E E S T A N D I N G

DATASHEET

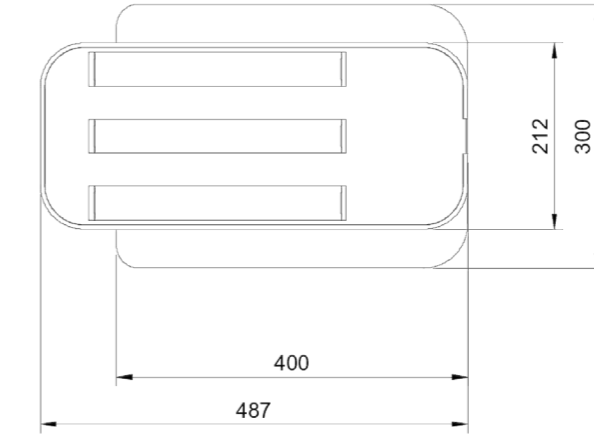

PRODUCT DATA

Size : 487 x 212 x 1900 mm
Weight : 6,8 kg
Materials: Housing : Natural solid wood
 Reflector: Polycarbonate lens + reflector
 Base plate: Aluminium
Optic : Dark Light Reflector 80 °
Light distribution : Direct 40 % , Indirect 60 %
Driver : FIX, DALI, Bluetooth (build in)
Sensor : Daylight and movement
Ambient temperature : 0 / + 35 °C
Lifetime : L80B10 - 60 000 hours
Installation : freestanding

WOOD FREESTANDING LED

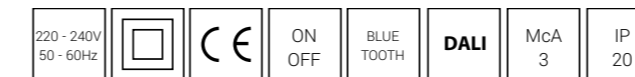

WOOD OPTIONS

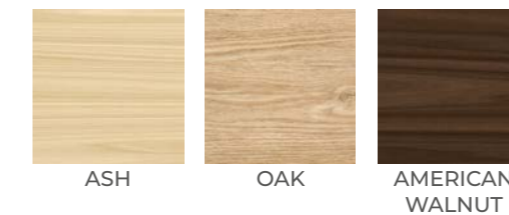

TECHNICAL SPECIFICATION

CODE	POWER	CRI	CCT	LUMEN
WFS	68 W	> 90	3000 K	7600 lm
WFS	68 W	> 90	4000 K	8000 lm
WFS	68 W	> 90	TW (2700 - 6500 K)	7600 lm

Order example:

WFS	-	Power	-	CRI / CCT	-	Beam	-	Wood	-	Driver	-	Option
WFS	-	45	-	930	-	80	-	OAK	-	FIX	-	XYZ





**WOOD ROUND LED 600x110
DIFFUSE**

Wood Round LED 600 is a direct or direct / indirect emitting LED luminaire with integrated LED driver. The optical system is featured by a satinated diffusor. The wood patterns are vertical around the diameter. The solid segmented bottom ring has horizontal wood patterns.

Surface threatchments: Natural, oiled, antibacterial coating with silver nano-particles (flame retardant according to DIN 4102 B1)



**WOOD ROUND LED 850x110
DIFFUSE**

Wood Round LED 850 is a direct or direct / indirect emitting LED luminaire with integrated LED driver. The optical system is featured by a satinated diffusor. The wood patterns are vertical around the diameter. The solid segmented bottom ring has horizontal wood patterns.

Surface threatchments: Natural, oiled, antibacterial coating with silver nano-particles (flame retardant according to DIN 4102 B1)



**WOOD ROUND LED 1100x110
DIFFUSE**

Wood Round LED 1100 is a direct or direct / indirect emitting LED luminaire with integrated LED driver. The optical system is featured by a satinated diffusor. The wood patterns are vertical around the diameter. The solid segmented bottom ring has horizontal wood patterns.

Surface threatchments: Natural, oiled, antibacterial coating with silver nano-particles (flame retardant according to DIN 4102 B1)



WOOD ROUND LED 600x300 DIFFUSE

Wood Round LED 600 is a direct or direct / indirect emitting LED luminaire with integrated LED driver. The optical system is featured by a satinated diffuser. The wood patterns are vertical around the diameter. The solid segmented bottom ring has horizontal wood patterns.

Surface treatments: Natural, oiled, antibacterial coating with silver nano-particles (flame retardant according to DIN 4102 B1)



WOOD ROUND LED 850x300 DIFFUSE

Wood Round LED 850 is a direct or direct / indirect emitting LED luminaire with integrated LED driver. The optical system is featured by a satinated diffuser. The wood patterns are vertical around the diameter. The solid segmented bottom ring has horizontal wood patterns.

Surface treatments: Natural, oiled, antibacterial coating with silver nano-particles (flame retardant according to DIN 4102 B1)



WOOD ROUND LED 1100x300 DIFFUSE

Wood Round LED 1100 is a direct or direct / indirect emitting LED luminaire with integrated LED driver. The optical system is featured by a satinated diffuser. The wood patterns are vertical around the diameter. The solid segmented bottom ring has horizontal wood patterns.

Surface treatments: Natural, oiled, antibacterial coating with silver nano-particles (flame retardant according to DIN 4102 B1)



WOOD DOWNLIGHT SQUARE DIFFUSE

Wood Downlight Square is a downlight in square shape. The optical system is based on a satinated diffuser. On vertical services is a decorative lightline. The aura effect is brightening the ceiling.

Surface treatments: Natural, oiled, antibacterial coating with silver nano-particles (flame retardant according to DIN 4102 B1)



WOOD LINEAR 50 LED DIFFUSE

Wood Linear 50 LED is a luminaire with a satinated optical system. The illumination is direct or direct / indirect.

Surface treatments: Natural, oiled, antibacterial coating with silver nano-particles (flame retardant according to DIN 4102 B1)



WOOD ROUND LED 400x700 DIFFUSE

Wood Round LED 400 is a direct or direct / indirect emitting LED luminaire with integrated LED driver. The optical system is featured by a satinated diffuser. The wood patterns are vertical around the diameter. The solid segmented bottom ring has horizontal wood patterns.

Surface treatments: Natural, oiled, antibacterial coating with silver nano-particles (flame retardant according to DIN 4102 B1)



D O W N L I G H T S Q U A R E

DATASHEET

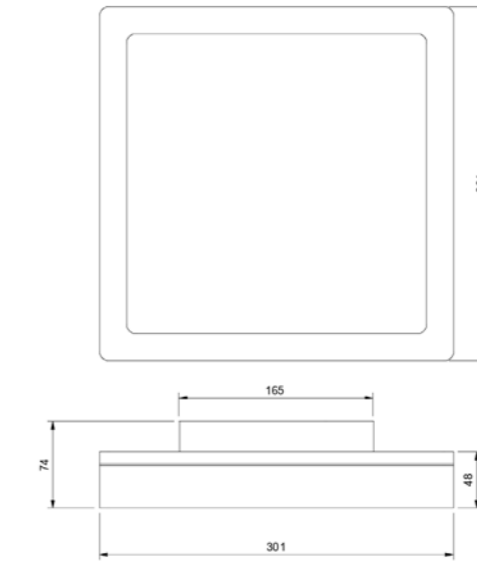

PRODUCT DATA

Size : 301 x 301 x 74 mm
Weight : 1,6 kg
Materials : Housing : Natural solid wood
 Optic: PMMA
 Backplate: Aluminium
Optic : Diffusor / Microprisma
Light distribution : Direct / Indirect
Driver : FIX, DALI, Bluetooth (build in)
Ambient temperature : 0 / + 35 °C
Lifetime : L80B10 - 60 000 hours
Installation : surface mounted (ceiling, wall)

WOOD DOWNLIGHT SQUARE DIFFUSE

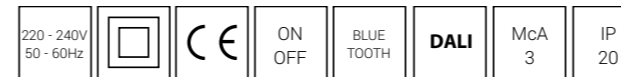

WOOD OPTIONS

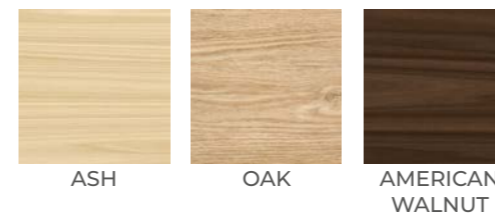

TECHNICAL SPECIFICATION

CODE	POWER	CRI	CCT	LUMEN
WSD300	18 W	> 90	3000 K	1700 lm
WSD300	18 W	> 90	4000 K	1800 lm
WSD300	18 W	> 90	TW (2700 - 6500 K)	1700 lm

Order example:

WSD300	-	Power	-	CRI / CCT	-	Beam	-	Wood	-	Driver	-	Option
WSD300	-	18	-	930	-	DIFF	-	ASH	-	FIX	-	XYZ

DATASHEET



L I N E A R 5 0

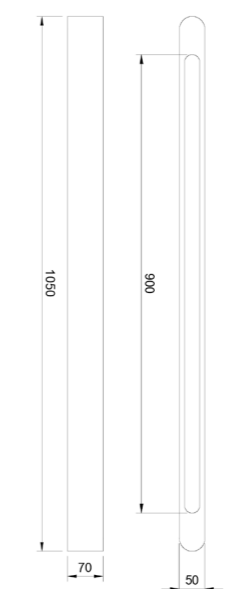

PRODUCT DATA

Size : 50 x 70 x1050 mm
 Weight : 1,5 kg
 Materials : Housing : Natural solid wood
 Optic: PMMA
 Base plate: Aluminium
 Optic : difusor / microprisma
 Light distribution : Direct
 Driver : FIX, DALI, Bluetooth (inside or on ceiling)
 Ambient temperature : 0 / + 35 °C
 Lifetime : L80B10 - 60 000 hours
 Installation : surface mounted

WOOD LINEAR 50
DIFFUSE

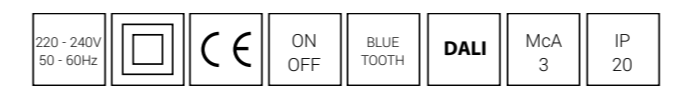

WOOD OPTIONS

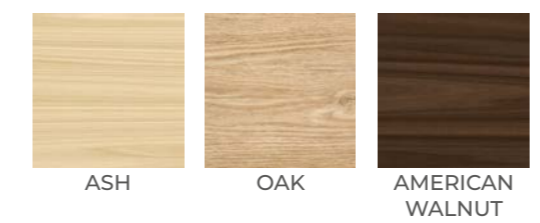

TECHNICAL SPECIFICATION

CODE	POWER	CRI	CCT	LUMEN
WL50DIFF	27 W	> 90	3000 K	2700 lm
WL50DIFF	27 W	> 90	4000 K	2750 lm
WL50DIFF	28 W	> 90	TW (2700 - 6500 K)	2700 lm

Order example:

WL50DIFF	-	Power	-	CRI / CCT	-	Beam	-	Wood	-	Driver	-	Option
WL50DIFF	-	27	-	930	-	DIFF	-	ASH	-	FIX	-	XYZ



R O U N D 4 0 0 x 7 0 0

DATASHEET

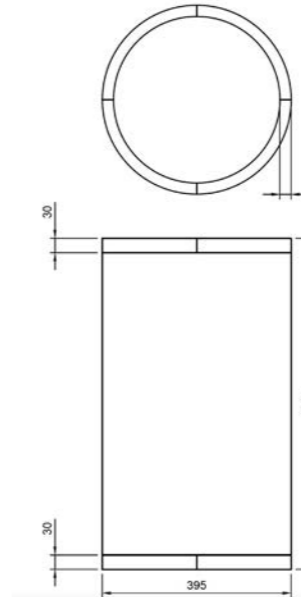

PRODUCT DATA

Size : 395 x 395 x 691 mm
 Weight : 11,5 kg
 Materials : Housing : Natural solid wood
 Optic: PMMA
 Backplate: Aluminium
 Optic : Diffusor / Microprisma
 Light distribution : lambertian
 Driver : FIX, DALI, Bluetooth (build in)
 Ambient temperature : 0 / + 35 °C
 Lifetime : L80B10 - 60 000 hours
 Installation : surface mounted, suspended

WOOD ROUND LED 400x700 DIFFUSE

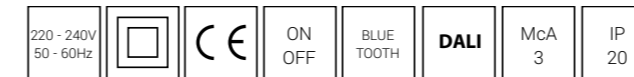

WOOD OPTIONS

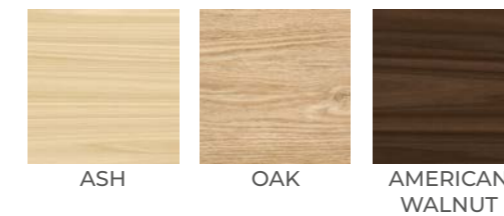

TECHNICAL SPECIFICATION

CODE	POWER	CRI	CCT	LUMEN
WR400x700MR	84 W	> 90	3000 K	6345 lm
WR400x700MR	84 W	> 90	4000 K	7050 lm

Order example:

WR400x700MR	-	Power	-	CRI / CCT	-	Beam	-	Wood	-	Driver	-	Option
WR400x700MR	-	84	-	930	-	DIFF	-	OAK	-	FIX	-	XYZ



R O U N D 4 0 0 x 1 1 0

DATASHEET

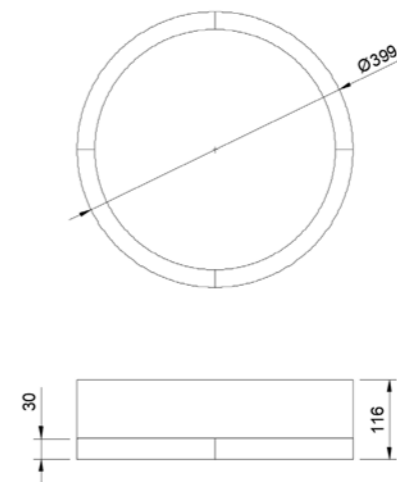

PRODUCT DATA

Size : 400 x 400 x 110 mm
 Weight : 2.6 kg
 Materials : Housing : Natural solid wood
 Optic : PMMA
 Backplate : Aluminium
 Optic : Diffusor / Microprisma
 Light distribution : lambertian
 Driver : FIX, DALI, Bluetooth (build in)
 Ambient temperature : 0 / + 35 °C
 Lifetime : L80B10 - 60 000 hours
 Installation : surface mounted, suspended

WOOD ROUND LED 400x110 DIFFUSE



WOOD OPTIONS

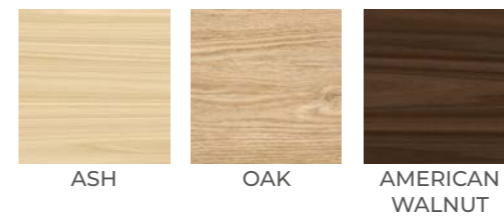

TECHNICAL SPECIFICATION

CODE	POWER	CRI	CCT	LUMEN
WR400x110MR	52 W	> 90	3000 K	3900 lm
WR400x110MR	52 W	> 90	4000 K	4134lm

Order example:

WR400x110MR	-	Power	-	CRI / CCT	-	Beam	-	Wood	-	Driver	-	Option
WR400x110MR	-	52	-	930	-	DIFF	-	OAK	-	FIX	-	XYZ



R O U N D 6 0 0 x 1 1 0

DATASHEET

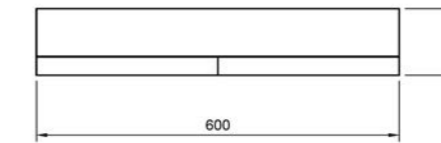
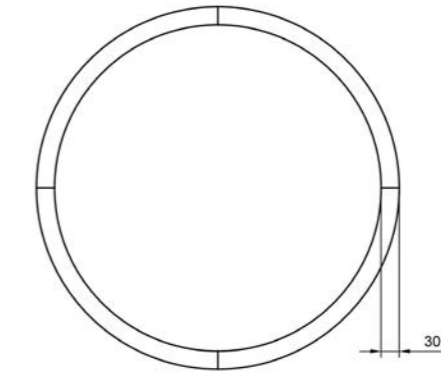

PRODUCT DATA

Size : 600 x 600 x 110 mm
 Weight : 4 kg
 Materials : Housing : Natural solid wood
 Optic: PMMA
 Backplate:: Aluminium
 Optic : Diffusor / Microprisma
 Light distribution : lambertian
 Driver : FIX, DALI, Bluetooth (build in)
 Ambient temperature : 0 / + 35 °C
 Lifetime : L80B10 - 60 000 hours
 Installation : surface mounted, suspended

WOOD ROUND LED 600x110
DIFFUSE

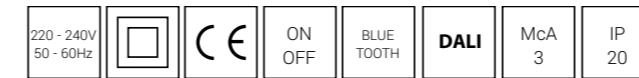

WOOD OPTIONS

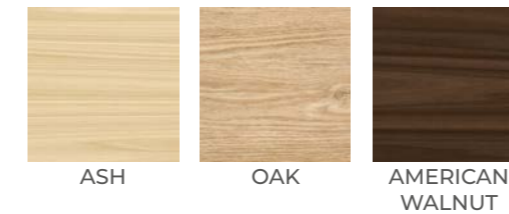

TECHNICAL SPECIFICATION

CODE	POWER	CRI	CCT	LUMEN
WR600x110MR	76 W	> 90	3000 K	6685 lm
WR600x110MR	76 W	> 90	4000 K	7750lm

Order example:

WR600x110MR	-	Power	-	CRI / CCT	-	Beam	-	Wood	-	Driver	-	Option
WR600x110MR	-	76	-	930	-	DIFF	-	OAK	-	FIX	-	XYZ

DATASHEET



R O U N D 8 5 0 x 1 1 0

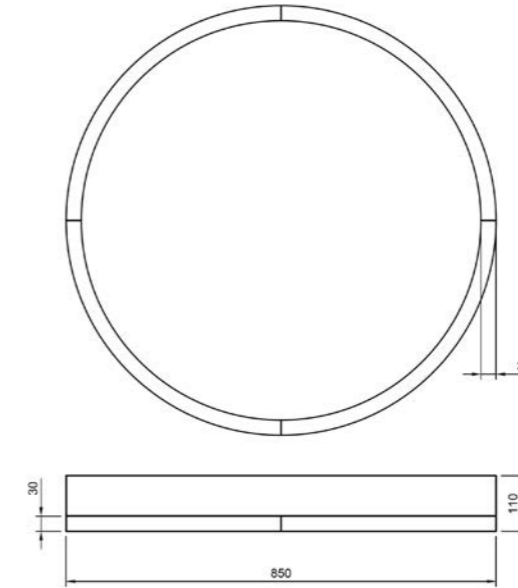

PRODUCT DATA

Size : 850 x 850 x 110 mm
 Weight : 10,8 kg
 Materials : Housing : Natural solid wood
 Optic: PMMA
 Backplate:: Aluminium
 Optic : Diffusor / Microprisma
 Light distribution : lambertian
 Driver : FIX, DALI, Bluetooth (build in)
 Ambient temperature : 0 / + 35 °C
 Lifetime : L80B10 - 60 000 hours
 Installation : surface mounted, suspended

WOOD ROUND LED 850x110
DIFFUSE

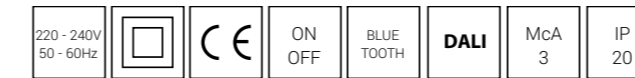

WOOD OPTIONS

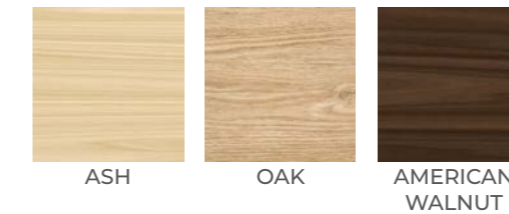

TECHNICAL SPECIFICATION

CODE	POWER	CRI	CCT	LUMEN
WR850x110MR	109 W	> 90	3000 K	10350 lm
WR850x110MR	109 W	> 90	4000 K	11400lm

Order example:

WR850x110MR	-	Power	-	CRI / CCT	-	Beam	-	Wood	-	Driver	-	Option
WR850x110MR	-	109	-	930	-	DIFF	-	OAK	-	FIX	-	XYZ

DATASHEET



R O U N D 1 1 0 0 x 1 1 0

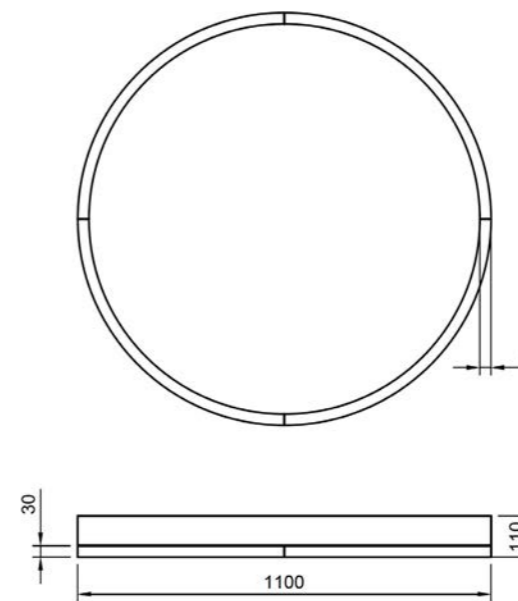

PRODUCT DATA

Size : 1100 x 1100 x 110 mm
 Weight : 18,2 kg
 Materials : Housing : Natural solid wood
 Optic: PMMA
 Backplate: Alluminium
 Optic : Diffusor / Microprisma
 Light distribution : lambertian
 Driver : FIX, DALI, Bluetooth (build in)
 Ambient temperature : 0 / + 35 °C
 Lifetime : L80B10 - 60 000 hours
 Installation : surface mounted, suspended

WOOD ROUND LED 1100x110
DIFFUSE

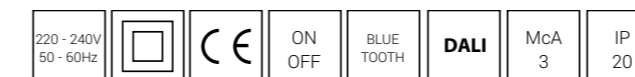

WOOD OPTIONS

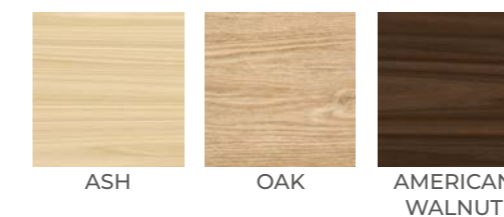

TECHNICAL SPECIFICATION

CODE	POWER	CRI	CCT	LUMEN
WR1100x110MR	128W	> 90	3000 K	12140 lm
WR1100x110MR	128 W	> 90	4000 K	13400lm

Order example:

WR850x110MR	-	Power	-	CRI / CCT	-	Beam	-	Wood	-	Driver	-	Option
WR850x110MR	-	109	-	930	-	DIFF	-	OAK	-	FIX	-	XYZ

DATASHEET



R O U N D 6 0 0 x 3 0 0

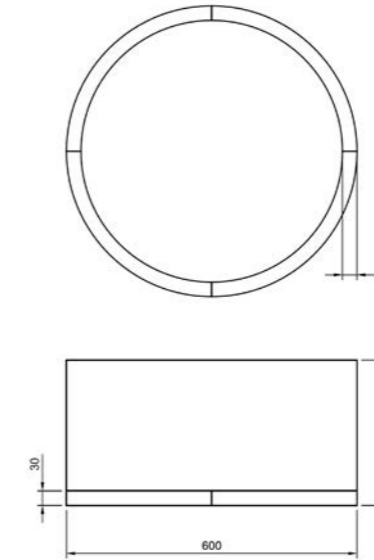

PRODUCT DATA

Size : 600 x 600 x 300 mm
 Weight : 4,8 kg
 Materials : Housing : Natural solid wood
 Optic: PMMA
 Backplate: Aluminium
 Optic : Diffusor / Microprisma
 Light distribution : lambertian
 Driver : FIX, DALI, Bluetooth (build in)
 Ambient temperature : 0 / + 35 °C
 Lifetime : L80B10 - 60 000 hours
 Installation : surface mounted, suspended

WOOD ROUND LED 600x300
DIFFUSE

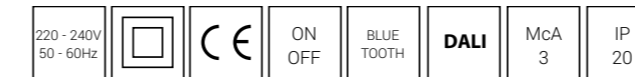

WOOD OPTIONS

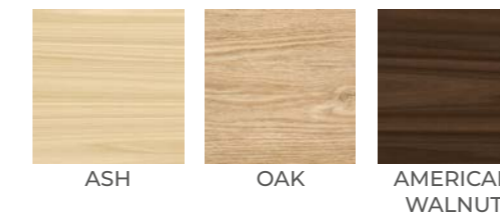

TECHNICAL SPECIFICATION

CODE	POWER	CRI	CCT	LUMEN
WR600x300MR	76 W	> 90	3000 K	6685 lm
WR600x300MR	76 W	> 90	4000 K	7550 lm

Order example:

WR600x300MR	-	Power	-	CRI / CCT	-	Beam	-	Wood	-	Driver	-	Option
WR600x300MR	-	76	-	930	-	DIFF	-	OAK	-	FIX	-	XYZ



R O U N D 8 5 0 x 3 0 0

DATASHEET

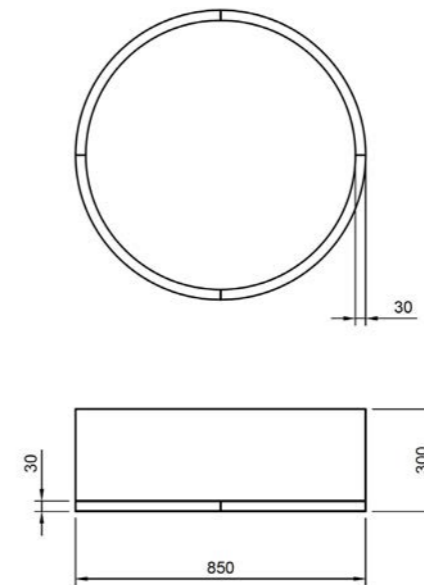

PRODUCT DATA

Size : 850 x 850 x 300 mm
Weight : 13,2 kg
Materials : Housing : Natural solid wood
 Optic: PMMA
 Backplate: Aluminium
Optic : Diffusor / Microprisma
Light distribution : lambertian
Driver : FIX, DALI, Bluetooth (build in)
Ambient temperature : 0 / + 35 °C
Lifetime : L80B10 - 60 000 hours
Installation : surface mounted, suspended

WOOD ROUND LED 850x300 DIFFUSE



WOOD OPTIONS

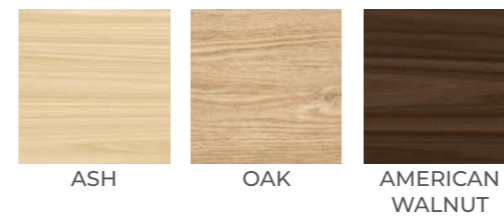

TECHNICAL SPECIFICATION

CODE	POWER	CRI	CCT	LUMEN
WR850x300MR	109 W	> 90	3000 K	10350 lm
WR850x300MR	109 W	> 90	4000 K	11400 lm

Order example:

WR850x300MR	-	Power	-	CRI / CCT	-	Beam	-	Wood	-	Driver	-	Option
WR850x300MR	-	109	-	930	-	DIFF	-	OAK	-	FIX	-	XYZ



R O U N D 1 1 0 0 x 3 0 0

DATASHEET

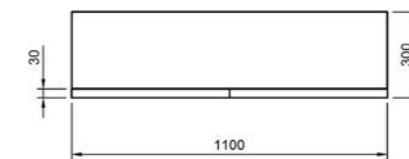
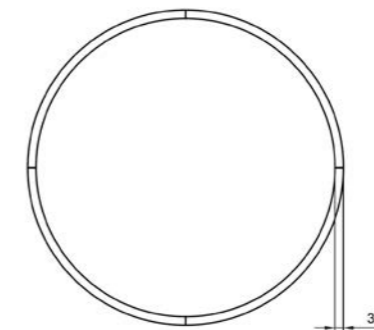

PRODUCT DATA

Size : 1100 x 1100 x 300 mm
 Weight : 25 kg
 Materials : Housing : Natural solid wood
 Optic: PMMA
 Backplate: Aluminium
 Optic : Diffusor / Microprisma
 Light distribution : lambertian
 Driver : FIX, DALI, Bluetooth (build in)
 Ambient temperature : 0 / + 35 °C
 Lifetime : L80B10 - 60 000 hours
 Installation : surface mounted, suspended

WOOD ROUND LED 1100x300 DIFFUSE



WOOD OPTIONS

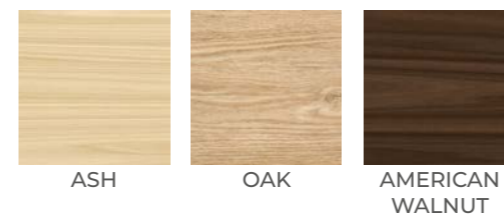

TECHNICAL SPECIFICATION

CODE	POWER	CRI	CCT	LUMEN
WR1100x300MR	128 W	> 90	3000 K	12140 lm
WR1100x300MR	128 W	> 90	4000 K	13400 lm

Order example:

WR1100x300MR	-	Power	-	CRI / CCT	-	Beam	-	Wood	-	Driver	-	Option
WR1100x300MR	-	128	-	930	-	DIFF	-	OAK	-	FIX	-	XYZ





WOOD RING DUAL 400 / 610 / 860 / 1160 LED

Wood Ring Dual is a round ring luminaire with direct and indirect illumination. It is a combination of a classic and wood luminaire and combines both worlds. The inside part is made of powder coated Aluminium or real brass, the outside ring is made of solid wood. The advantage of this design series is the wide usage of this piece of art, from rustical till modern design spaces.

Surface treatments: Natural, oiled, antibacterial coating with silver nano-particles (flame retardant according to DIN 4102 B1)



WOOD ELLIPSE DUAL 1050 x 725 / 1500 x 825

Wood Elypse Dual is a luminaire in ellipse shape with direct and indirect illumination. It is a combination of a classic and wood luminaire and combines both worlds. The inside part is made of Aluminium with many powder coating color options or even real brass, the outside ellipse is made of solid wood. The advantage of this design series is the wide usage of this piece of art, from rustical to modern design spaces.

Surface treatments: Natural, oiled, antibacterial coating with silver nano-particles (flame retardant according to DIN 4102 B1)



WOOD SQUARE DUAL 550 / 780

Wood Square Dual is a square spaped luminaire with direct and indirect illumination. It is a combination of a classic and wood luminaire and combines both worlds. The inside part is made of powder coated Aluminium or real brass, the outside ring is made of solid wood. The advantage of this design series is the wide usage of this piece of art, from rustical till modern design spaces.

Surface treatments: Natural, oiled, antibacterial coating with silver nano-particles (flame retardant according to DIN 4102 B1)



WOOD CHANDELIER

Wood Chanelier Dual is an impressive chandelier with direct and indirect illumination. It is a combination of a classic and wood luminaire and combines both worlds. The inside part is made of Aluminium with many powder coating color options or even real brass, the outside frames are made of solid wood. The advantage of this design series is the wide usage of this piece of art, from rustical to modern design spaces.

Surface treatments: Natural, oiled, antibacterial coating with silver nano-particles (flame retardant according to DIN 4102 B1)



R I N G D U A L 4 0 0

DATASHEET

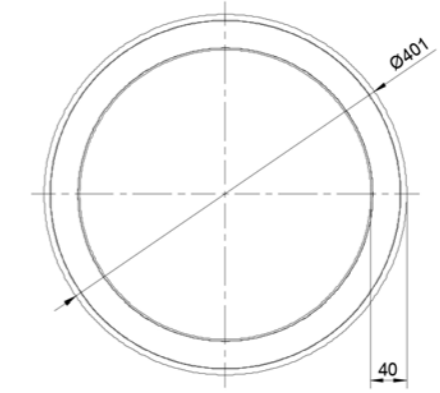

PRODUCT DATA

Size : 401 x 410 x 52 mm
Weight : 4,2 kg
Materials : Housing : Natural solid wood
 Optic: PMMA
 Ground plate: Aluminium
Optic : Diffusor
Light distribution : Direct 55 % , Indirect 45 %
Driver : FIX, DALI, Bluetooth
Ambient temperature : 0 / + 35 °C
Lifetime : L80B10 - 60 000 hours
Installation : suspended

WOOD RING DUAL 400 LED

220 - 240V
50 - 60Hz

WOOD OPTIONS

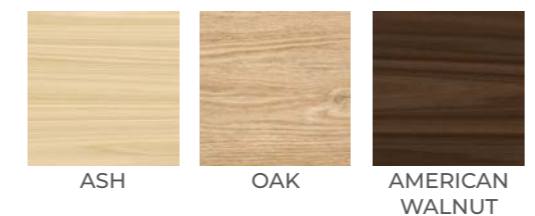

TECHNICAL SPECIFICATION

CODE	POWER	CRI	CCT	LUMEN
WRI400x52DUAL	31 W	> 90	3000 K	2015 lm
WRI400x52DUAL	31 W	> 90	4000 K	2100 lm
WRI400x52DUAL	31 W	> 90	TW (2700 - 6500 K)	2015 lm

Order example:

WRI400x52DUAL - Power - CRI / CCT - Beam - Wood - Driver - OPTION
 WRI400x52DUAL - 31 - 930 - DIFF - OAK - FIX - XYZ



R I N G D U A L 6 1 0

DATASHEET

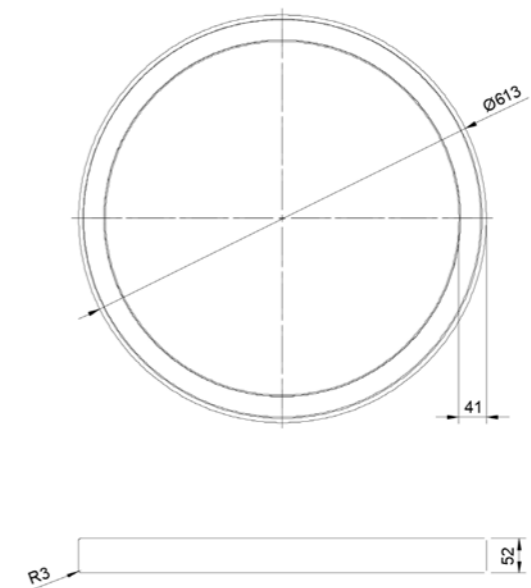

PRODUCT DATA

Size : 613 x 613 x 52 mm
Weight : 4,8 kg
Materials : Housing : Natural solid wood
 Optic: PMMA
 Base plate: Aluminium
Optic : Diffusor
Light distribution : Direct 55% , indirect 45%
Driver : FIX, DALI, Bluetooth (inside or on ceiling)
Ambient temperature : 0 / + 35 °C
Lifetime : L80B10 - 60 000 hours
Installation : suspended

WOOD RING DUAL 610 LED



WOOD OPTIONS

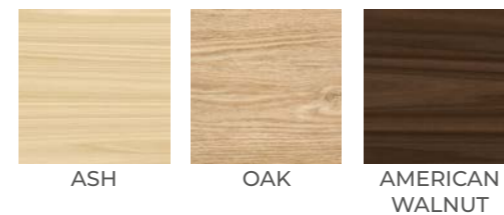

TECHNICAL SPECIFICATION

CODE	POWER	CRI	CCT	LUMEN
WRI610x52DUAL	51 W	> 90	3000 K	3264 lm
WRI610x52DUAL	51 W	> 90	4000 K	3525 lm
WRI610x52DUAL	51 W	> 90	TW (2700 - 6500 K)	3264 lm

Order example:

WRI610x52DUAL	-	Power	-	CRI / CCT	-	Beam	-	Wood	-	Driver	-	Option
WRI610x52DUAL	-	51	-	930	-	DIFF	-	OAK	-	FIX	-	XYZ



R I N G D U A L 8 6 0

DATASHEET

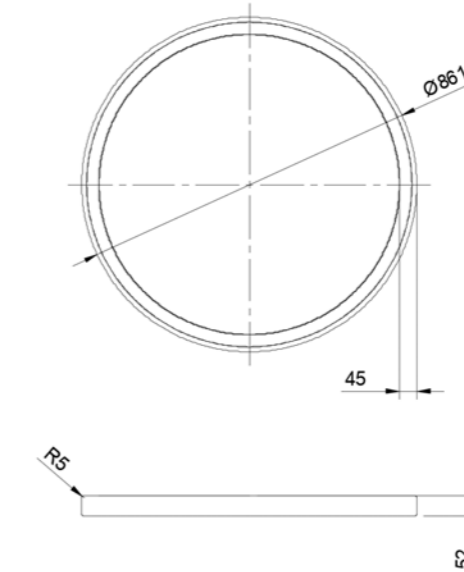

PRODUCT DATA

Size : 860 x 860 x 52 mm
Weight : 6,8 kg
Materials : Housing : Natural solid wood
 Optic: PMMA
 Base plate: Aluminium
Optic : Diffusor
Light distribution : Direct 55% , indirect 45%
Driver : FIX, DALI, Bluetooth (inside or on ceiling)
Ambient temperature : 0 / + 35 °C
Lifetime : L80B10 - 60 000 hours
Installation : suspended

WOOD RING DUAL 860 LED

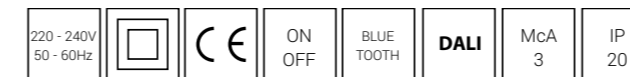

WOOD OPTIONS

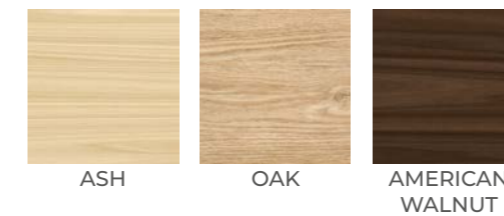

TECHNICAL SPECIFICATION

CODE	POWER	CRI	CCT	LUMEN
WRI860x52DUAL	75 W	> 90	3000 K	4350 lm
WRI860x52DUAL	75 W	> 90	4000 K	4430 lm
WRI860x52DUAL	75 W	> 90	TW (2700 - 6500 K)	4350 lm

Order example:

WRI860x52DUAL	-	Power	-	CRI / CCT	-	Beam	-	Wood	-	Driver	-	Option
WRI860x52DUAL	-	75	-	930	-	DIFF	-	OAK	-	FIX	-	XYZ



R I N G D U A L 1 1 6 0

DATASHEET

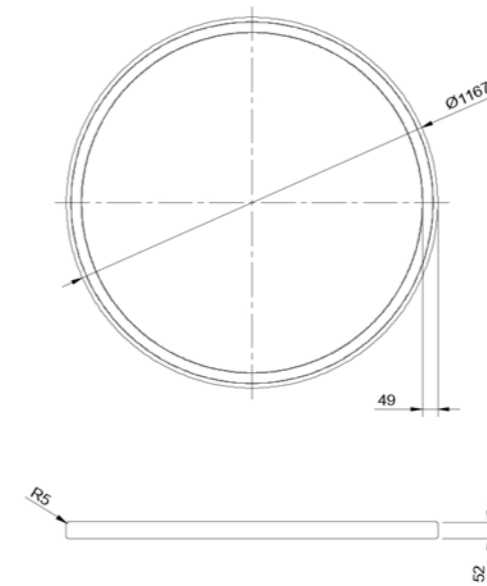

PRODUCT DATA

Size : 1160 x 1160 x 52 mm
 Weight : 8,8 kg
 Materials : Housing : Natural solid wood
 Optic: PMMA
 Base plate: Aluminium
 Optic : Diffusor
 Light distribution : Direct 55% , indirect 45%
 Driver : FIX, DALI, Bluetooth (inside or on ceiling)
 Ambient temperature : 0 / + 35 °C
 Lifetime : L80B10 - 60 000 hours
 Installation : suspended

WOOD RING DUAL 1160 LED



WOOD OPTIONS

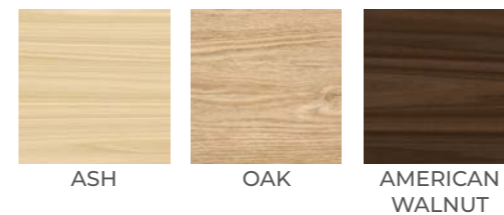

TECHNICAL SPECIFICATION

CODE	POWER	CRI	CCT	LUMEN
WRI1160x52DUAL	92 W	> 90	3000 K	5915lm
WRI1160x52DUAL	92 W	> 90	4000 K	6388 lm
WRI1160x52DUAL	92 W	> 90	TW (2700 - 6500 K)	5915 lm

Order example:

WRI1160x52DUAL	-	Power	-	CRI / CCT	-	Beam	-	Wood	-	Driver	-	Option
WRI1160x52DUAL	-	92	-	930	-	DIFF	-	OAK	-	FIX	-	XYZ



R I N G D U A L 6 3 6

DATASHEET

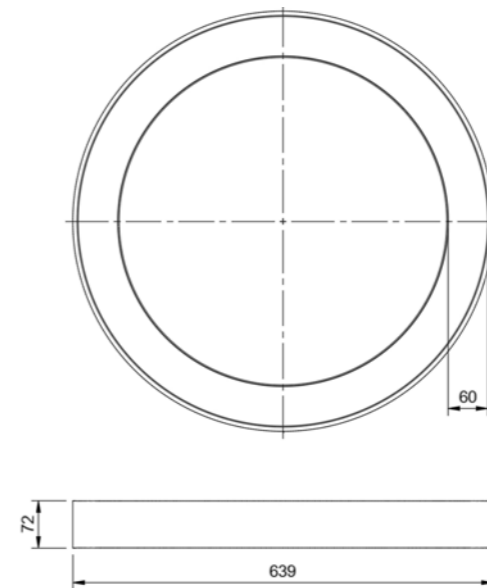

PRODUCT DATA

Size : 636 x 636 x 72 mm
 Weight : 5 kg
 Materials : Housing : Natural solid wood
 Optic: PMMA
 Base plate: Aluminium
 Optic : Diffusor (DIFF) / Microprisma (MICRO)
 Light distribution : Direct 55% , indirect 45%
 Driver : FIX, DALI, Bluetooth (inside or on ceiling)
 Ambient temperature : 0 / + 35 °C
 Lifetime : L80B10 - 60 000 hours
 Installation : suspended

WOOD RING DUAL 636 LED



WOOD OPTIONS

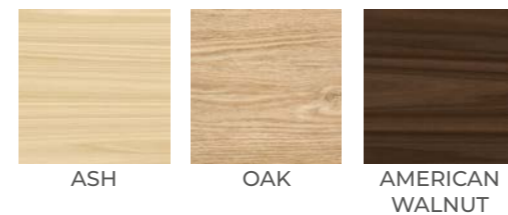

TECHNICAL SPECIFICATION

CODE	POWER	CRI	CCT	LUMEN
WRI636x72DUAL	51 W	> 90	3000 K	3264 lm
WRI636x72DUAL	51 W	> 90	4000 K	3525 lm
WRI636x72DUAL	51 W	> 90	TW (2700 - 6500 K)	3264 lm

Order example:

WRI636x72DUAL	-	Power	-	CRI / CCT	-	Beam	-	Wood	-	Driver	-	Option
WRI636x72DUAL	-	51	-	930	-	DIFF	-	OAK	-	FIX	-	XYZ



R I N G D U A L 8 7 7

DATASHEET

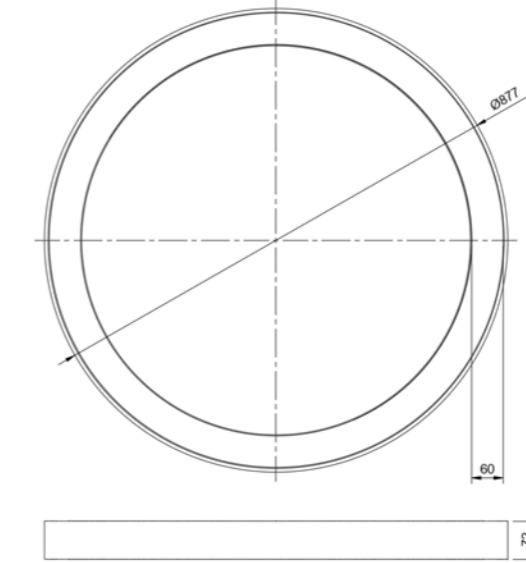

PRODUCT DATA

Size : 877 x 877 x 72 mm
Weight : 7 kg
Materials : Housing : Natural solid wood
 Optic: PMMA
 Base plate: Aluminium
Optic : Diffusor (DIFF) / Microprisma (MICRO)
Light distribution : Direct 55% , indirect 45%
Driver : FIX, DALI, Bluetooth (inside or on ceiling)
Ambient temperature : 0 / + 35 °C
Lifetime : L80B10 - 60 000 hours
Installation : suspended

WOOD RING DUAL 877 LED

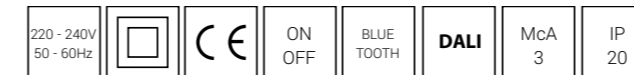

WOOD OPTIONS

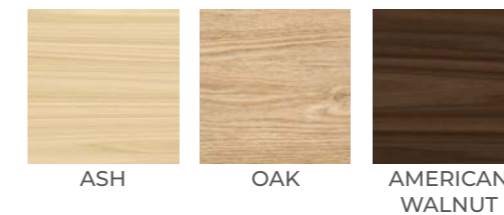

TECHNICAL SPECIFICATION

CODE	POWER	CRI	CCT	LUMEN
WRI877x72DUAL	75 W	> 90	3000 K	4350 lm
WRI877x72DUAL	75 W	> 90	4000 K	4430 lm
WRI877x72DUAL	75 W	> 90	TW (2700 - 6500 K)	4350 lm

Order example:

WRI877x72DUAL	-	Power	-	CRI / CCT	-	Beam	-	Wood	-	Driver	-	Option
WRI877x72DUAL	-	75	-	930	-	DIFF	-	OAK	-	FIX	-	XYZ



R I N G D U A L 1 1 8 6

DATASHEET

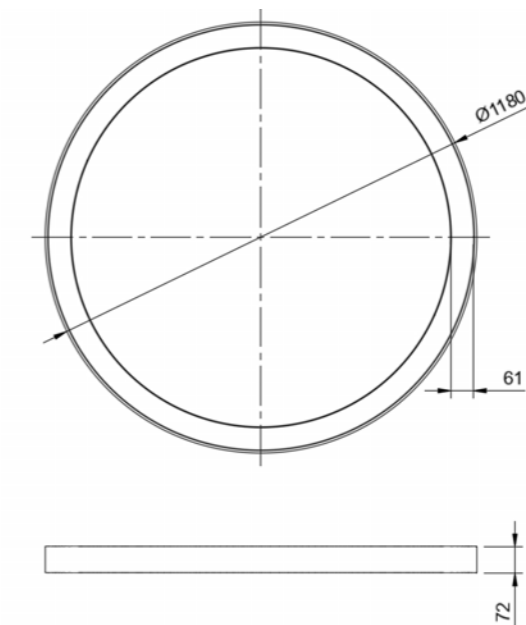

PRODUCT DATA

Size : 1186 x 1186 x 72 mm
 Weight : 8,8 kg
 Materials : Housing : Natural solid wood
 Optic: PMMA
 Base plate: Aluminium
 Optic : Diffusor (DIFF) / Microprisma (MICRO)
 Light distribution : Direct 55% , indirect 45%
 Driver : FIX, DALI, Bluetooth (inside or on ceiling)
 Ambient temperature : 0 / + 35 °C
 Lifetime : L80B10 - 60 000 hours
 Installation : suspended

WOOD RING DUAL 1186LED



WOOD OPTIONS

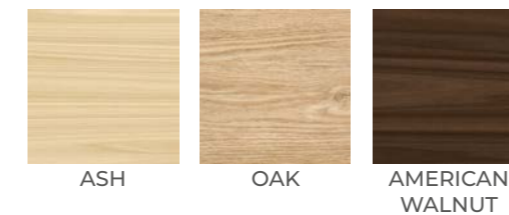

TECHNICAL SPECIFICATION

CODE	POWER	CRI	CCT	LUMEN
WRI1186x72DUAL	92 W	> 90	3000 K	5915lm
WRI1186x72DUAL	92 W	> 90	4000 K	6388 lm
WRI1186x72DUAL	92 W	> 90	TW (2700 - 6500 K)	5915 lm

Order example:

WRI1186x72DUAL	-	Power	-	CRI / CCT	-	Beam	-	Wood	-	Driver	-	Option
WRI1186x72DUAL	-	92	-	930	-	DIFF	-	OAK	-	FIX	-	XYZ



ELLIPSE DUAL

DATASHEET

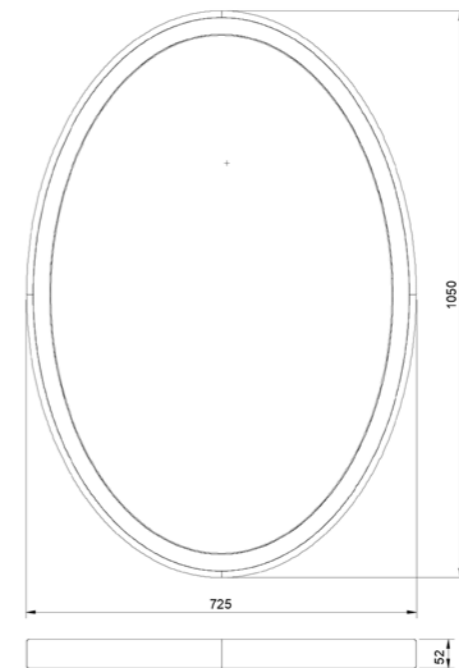

PRODUCT DATA

Size : 725 x 1050 x 52 mm
Weight : 6.8 kg
Materials : Housing : Natural solid wood
 Optic: PMMA
 Base plate: Aluminium
Optic : Diffusor
Light distribution : Direct 55 % , Indirect 45 %
Driver : FIX, DALI, Bluetooth (inside or on ceiling)
Ambient temperature : 0 / + 35 °C
Lifetime : L80B10 - 60 000 hours
Installation : suspended

WOOD ELLIPSE DUAL LED



WOOD OPTIONS

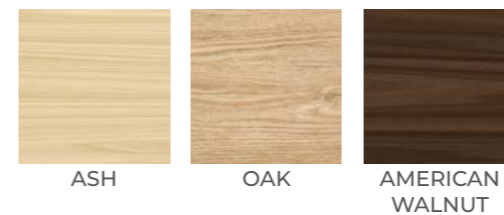

TECHNICAL SPECIFICATION

CODE	POWER	CRI	CCT	LUMEN
WELL	92 W	> 90	3000 K	5920 lm
WELL	92 W	> 90	4000 K	6380 lm
WELL	92 W	> 90	TW (2700 - 6500 K)	5920 lm

Order example:

WELL	-	Power	-	CRI / CCT	-	Beam	-	Wood	-	Driver	-	Option
WELL	-	92	-	930	-	80	-	OAK	-	FIX	-	XYZ



S Q U A R E D U A L 5 5 0

DATASHEET

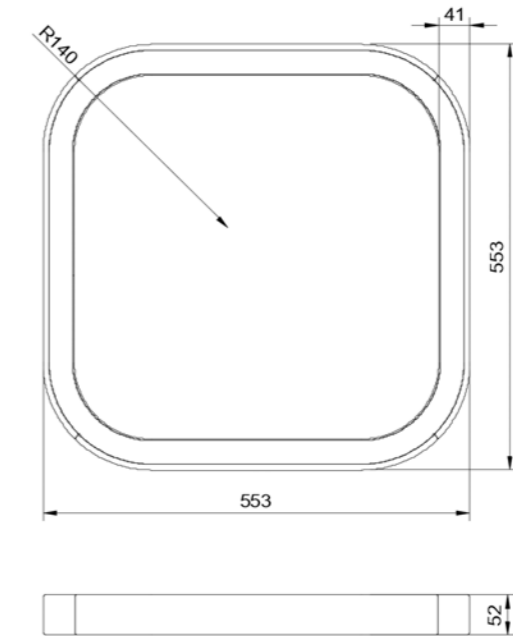

PRODUCT DATA

Size : 553 x 553 x 52 mm
 Weight : 4.8 kg
 Materials : Housing : Natural solid Wood
 Optic: PMMA
 Base plate: Aluminium

Optic : Diffusor
 Light distribution : Direct 55 % , Indirect 45 %
 Driver : FIX, DALI, Bluetooth (inside or on ceiling)
 Ambient temperature : 0 / + 35 °C
 Lifetime : L80B10 - 60 000 hours
 Installation : suspended
 Surface treatment : Natural, oiled, fire proof coating, anti-bacterial coating

WOOD SQUARE DUAL 550

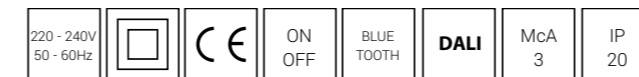

WOOD OPTIONS

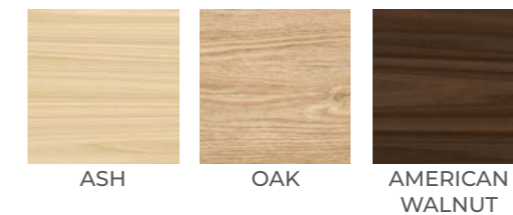

TECHNICAL SPECIFICATION

CODE	POWER	CRI	CCT	LUMEN
WSQ550x52DUAL	51 W	> 90	3000 K	3264 lm
WSQ550x52DUAL	51 W	> 90	4000 K	3525lm
WSQ550x52DUAL	51 W	> 90	TW (2700 - 6500 K)	3264 lm

Order example:

WSQ550x52DUAL	-	Power	-	CRI / CCT	-	Beam	-	Wood	-	Driver	-	Option
WSQ550x52DUAL	-	51	-	930	-	DIFF	-	OAK	-	FIX	-	XYZ



S Q U A R E D U A L 7 8 0

DATASHEET

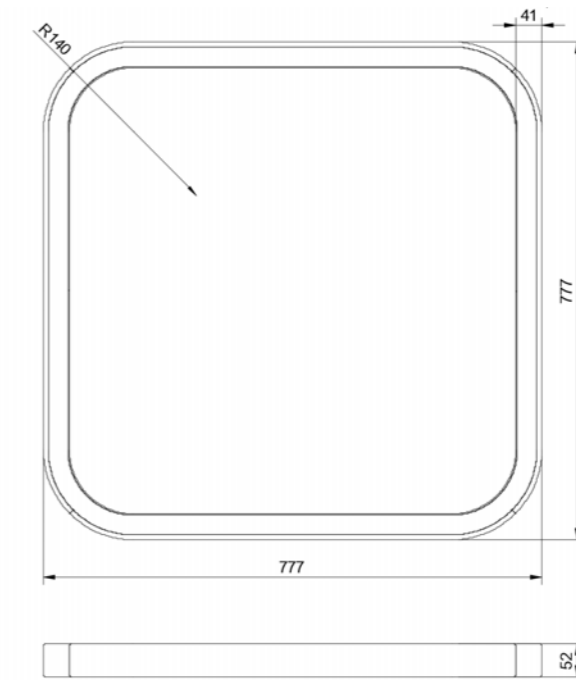

PRODUCT DATA

Size : 777 x 777 x 52 mm
 Weight: 6.8kg
 Materials : Housing : Natural solid Wood
 Optic: PMMA
 Base plate: Aluminium

Optic : Diffusor
 Light distribution : Direct 55 % , Indirect 45 %
 Driver : FIX, DALI, Bluetooth (inside or on ceiling)
 Ambient temperature : 0 / + 35 °C
 Lifetime : L80B10 - 60 000 hours
 Installation : suspended
 Surface treatment : Natural, oiled, fire proof coating, anti-bacterial coating

WOOD SQUARE DUAL 780

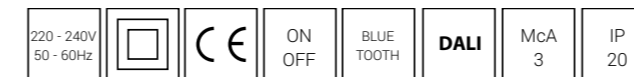

WOOD OPTIONS

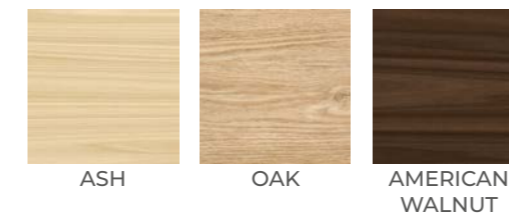

TECHNICAL SPECIFICATION

CODE	POWER	CRI	CCT	LUMEN
WSQ780x52DUAL	75 W	> 90	3000 K	4350 lm
WSQ780x52DUAL	75 W	> 90	4000 K	4430 lm
WSQ780x52DUAL	75 W	> 90	TW (2700-6500 K) K	4350 lm

Order example:

WSQ780x52DUAL	-	Power	-	CRI / CCT	-	Beam	-	Wood	-	Driver	-	Option
WSQ780x52DUAL	-	75	-	920	-	DIFF	-	OAK	-	FIX	-	XYZ



C H A N D E L I E R D U A L

DATASHEET

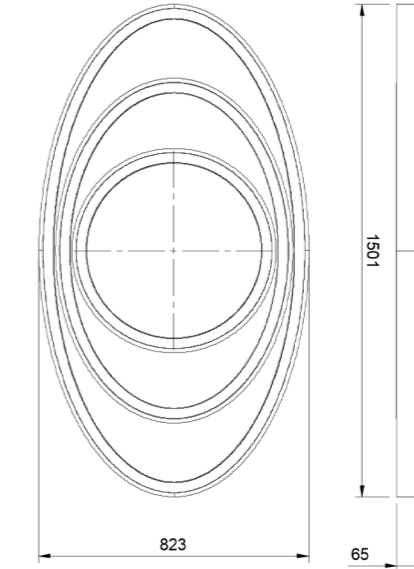

PRODUCT DATA

Size : 1500 x 825 x 65 mm
Weight : 16 kg
Materials : Housing : Natural solid Wood
 Optic: PMMA
 Base plate: Aluminium
Optic : Lambertian
Light distribution : Direct 50 % , Indirect 50 %
Driver : FIX, DALI, Bluetooth (inside or on ceiling)
Ambient temperature : 0 / + 35 °C
Lifetime : L80B10 - 60 000 hours
Installation : suspended

WOOD CHANDELIER DUAL LED

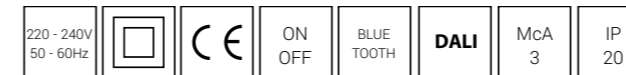

WOOD OPTIONS

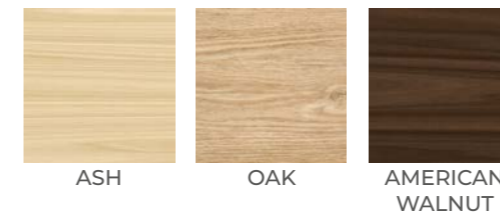

TECHNICAL SPECIFICATION

CODE	POWER	CRI	CCT	LUMEN
WCH3-1500x825x65DUAL	175 W	> 90	3000 K	10356 lm
WCH3-1500x825x65DUAL	175 W	> 90	4000 K	10770 lm
WCH3-1500x825x65DUAL	175 W	> 90	TW (2700 - 6500 K)	10356 lm

Order example:

WCH3-1500x825x65DUAL	-	Power	-	CRI / CCT	-	Beam	-	Wood	-	Driver	-	Option
WCH3-1500x825x65DUAL	-	175	-	930	-	DIFF	-	OAK	-	DALI	-	XYZ





WOOD microLINE EDGE

Wood microLine EDGE is a 48V based system. The solid wood bodies with share edges embrace the minimalistic rails, so that it gets visually one unit. The systems supports an unbelievable wide design possibility.

Surface treatments: Natural, oiled, antibacterial coating with silver nanoparticles (flame retardant according to DIN 4102 B1)



WOOD microLINE CURVED

Wood microLine CURVED is a 48V based system. The solid wood bodies with nicely curved shape embrace the minimalistic rails, so that it gets visually one unit. The systems supports an unbelievable wide design possibility.

Surface treatments: Natural, oiled, antibacterial coating with silver nanoparticles (flame retardant according to DIN 4102 B1)

COMPONENTS



microRail 1/4 CIRCLE
300 mm



microRail 1/4 CIRCLE
500 mm



microRail MIDDLE FEED



microRail END
FEED



microRail MIDDLE L
FEED

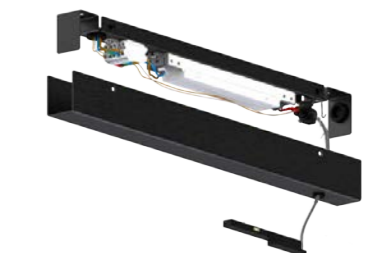

microRail DRIVER
100 W

DATASHEET



M I C R O L I N E C U R V E D

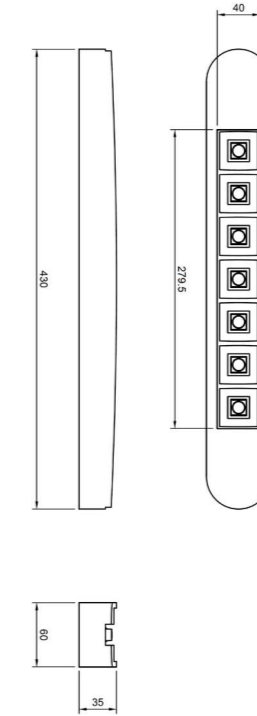

PRODUCT DATA

Size : 60 x 35 x 430 mm
 Weight : 0,8 kg
 Materials : Housing : Natural solid wood
 Optic: Polycarbonate lens + reflector
 Base plate: Aluminium
 Optic : Dark Light Reflector 80 °
 Light distribution : Direct
 Driver : FIX, DALI, Bluetooth (build in to connector)
 Ambient temperature : 0 / + 35 °C
 Lifetime : L80B10 - 60 000 hours
 Installation : suspended track with click system

WOOD MICROLINE CURVED

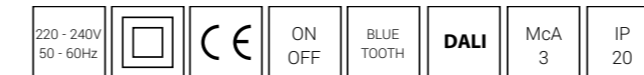

WOOD OPTIONS

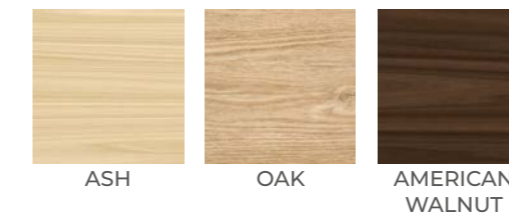

TECHNICAL SPECIFICATION

CODE	POWER	CRI	CCT	LUMEN
WML-WL60C-7x1	9 W	> 90	3000 K	1160 lm
WML-WL60C-7x1	9 W	> 90	4000 K	1210 lm

Order example:

WML-WL60C-7x1	-	Power	-	CRI / CCT	-	Beam	-	Wood	-	Driver	-	Option
WML-WL60C-7x1	-	9	-	930	-	80	-	ASH	-	FIX	-	XYZ

DATASHEET



M I C R O L I N E E D G E

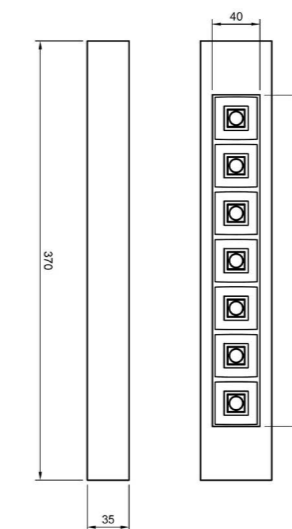

PRODUCT DATA

Size : 60 x 35 x 370 mm
 Weight : 0,8 kg
 Materials : Housing : Natural solid wood
 Optic: Polycarbonate lens + reflector
 Base plate: Aluminium
 Optic : Dark Light Reflector 80 °
 Light distribution : Direct
 Driver : FIX, DALI, Bluetooth (build in to connector)
 Ambient temperature : 0 / + 35 °C
 Lifetime : L80B10 - 60 000 hours
 Installation : suspended track with click system

WOOD MICROLINE EDGE

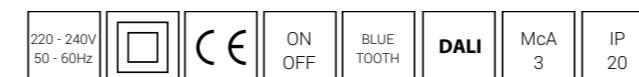

WOOD OPTIONS

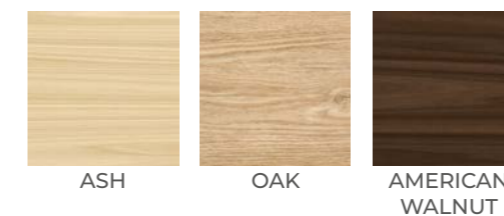

TECHNICAL SPECIFICATION

CODE	POWER	CRI	CCT	LUMEN
WML-WL60E-7x1	9 W	> 90	3000 K	1160 lm
WML-WL60E-7x1	9 W	> 90	4000 K	1210 lm

Order example:

WML-WL60E-7x1	-	Power	-	CRI / CCT	-	Beam	-	Wood	-	Driver	-	Option
WML-WL60E-7x1	-	9	-	930	-	80	-	ASH	-	FIX	-	XYZ

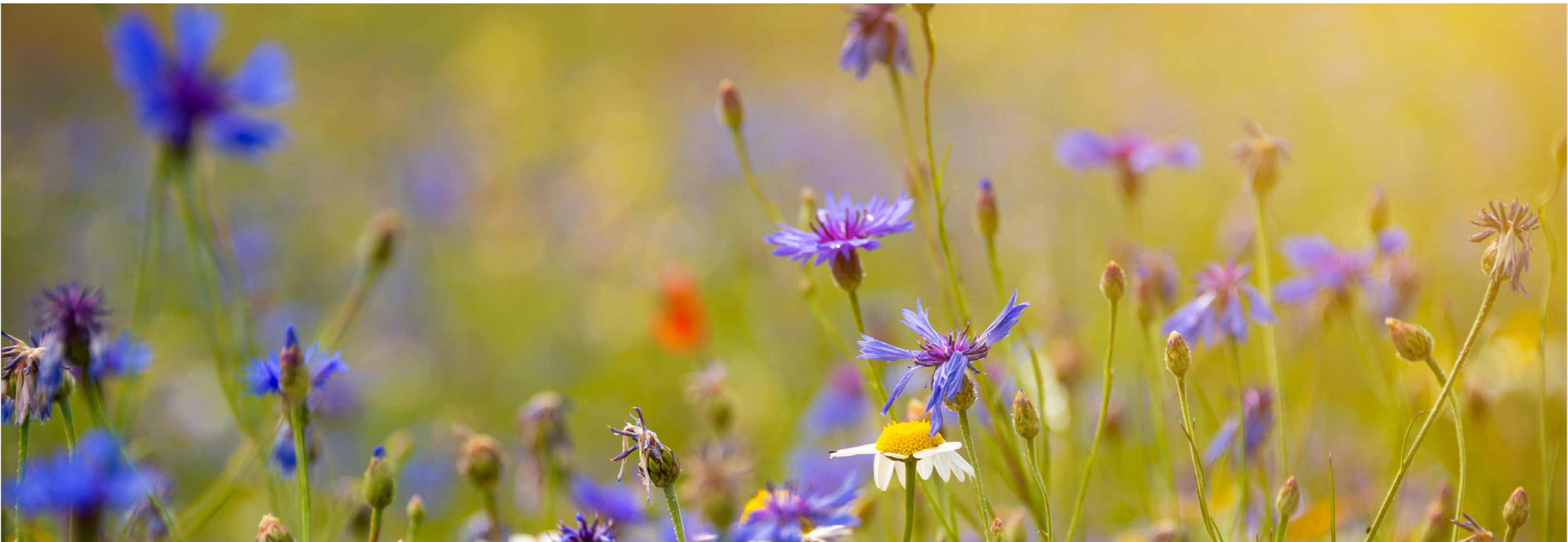

LOOK FEEL & SMELL



LOOK, FEEL AND SMELL

Experience the aroma of our natural materials every day, such as the smell of freshly ground coffee, hay, roses, moss and many more. The quality and unmistakable origin of our selected materials also determine the lighting experience. Without the addition of (artificial) fragrances or aromas, our natural materials provide with their natural fragrance good indoor climate.

FORM FOLLOWS FUNCTION

The term we live by the American sculptor Horatio Greenough was already mentioned in 1852 in connection with the organic principles of architecture by „form follows function“. This means that each individual luminaire focuses on the essentials instead of overloading the viewer or the room.

PERFECT ROOM CLIMATE

Our natural materials reflect, reveal, and enchant their surroundings, regardless of whether they are switched on or off. The indoor climate also benefits from the sound-absorbing effect of the natural materials. Each lamp is therefore unique, both our series products and the lamps with your very own fingerprint. The masterly and traditional craftsmanship of woodworking is our top priority and allows a unique piece to be created in meticulous detail. The optic arouses the curiosity to run your fingers over the wood type. Feel the origin of the hay from the steep slopes of Tyrol, the flowers from the alpine meadows or the moss wood types with lichen and pieces of bark.

THE ADVANTAGES AT A GLANCE

1 LOOK, FEEL AND SMELL

These are the unique combined properties of this collection. Depending on the application and material, the fragrance lasts between 3 and 10 years. If the scent wears off or you want to change the look , the panels can be reordered and replaced at any time.

3 SOUND ABSORBATION

Some natural materials are real performers when it comes to acoustics. By combining different layers of pure natural materials, even absorber class A specifications can be achieved! We also offer our customers additional wall panels that perfectly match the lights in terms of design and shape.

5 YOUR OWN DESIGN

As with our solid wood light portfolio, we offer customer-specific designs in the Look Feel and SMELL collection. Due to our manufacturing process consisting of CNC and hand-made finishing, new designs are possible within SIX weeks.

2 100% ANTI-ALLERGIC

Thanks to the innovative production process and years of development, our partner has managed to process these natural materials in such a way that they do not cause allergies. This has been confirmed by independent laboratories.

4 FLAME RETARDANT

The luminaires are also optionally available in B1 quality and thus correspond to fire protection class DIN 4102-1 for flame-retardant materials. This enables the use in public areas.





CORNFLOWER

THE COLOUR OF THE PETALS OF CORNFLOWER BLUE IS VERY INTENSE



ROSE

The petals of the rose: highly fragrant and colourful. Intensity of colour depending on availability of petals. Slight colour deviations are possible. No artificial colours or fragrant substances added.



VANILLA

The vanilla pods belong to our range of upcycle materials forming the intense smelling natural surface WANILLÄ.

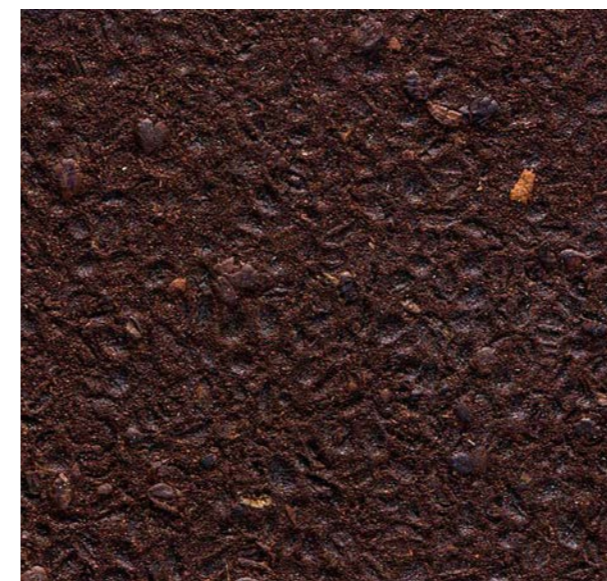

COFFEE

The coffee powder we use is one of our upcycling raw materials. The wonderful aroma is well-known and characteristic.



MOSS

The dark green moss we use is one of our upcycling materials

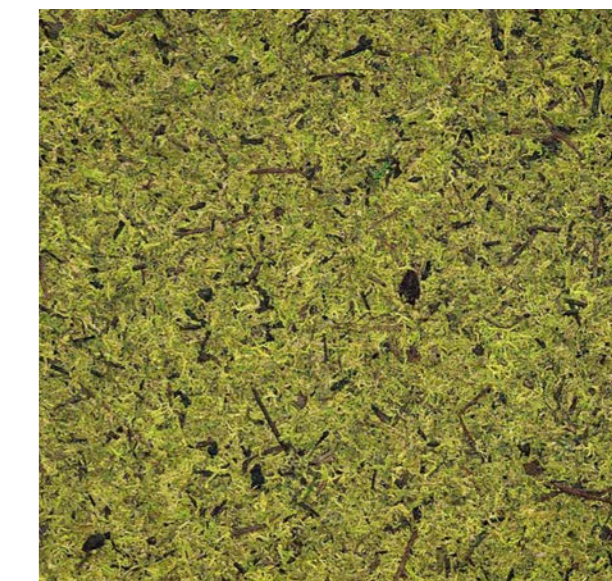

MOSS LIGHT

The light green moss we use is one of our upcycling materials

N A T U R A L M A T E R I A L S

L O O K - F E E L - S M E L L



HAY & CORNFLOWER

The delicately scented organic alpine-hay is discreetly gilded with rose petals which give the natural surface a slightly red tint



HAY & ROSE

The delicately scented organic alpine-hay is discreetly gilded with rose petals which give the natural surface a slightly red tint



ALPHAY MIX

A special mix of alpine-hay, marguerites in various sizes, edelweiss and petals of cornflowers, rose and heather



LAVENDER

Lavender has been known for centuries for its soothing and harmonizing effect. The intense natural scent is a remedy for uneasiness and sleep-onset insomnia

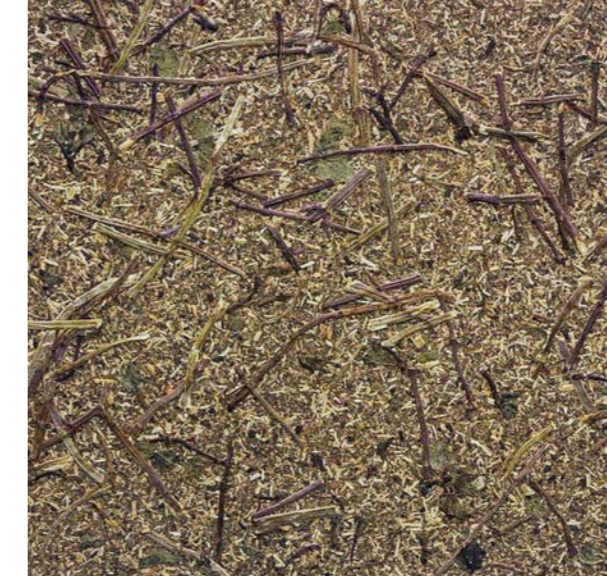

PEPPERMINT

The cooling and refreshing peppermint is one of our upcycling raw materials. In our production we use stems which are not suitable for tea production



SUNFLOWERS

The husks of sunflower seeds are one of our upcycling raw materials.

N A T U R A L M A T E R I A L S

L O O K - F E E L - S M E L L



WOOD SQUARE LED 60 - 600 LFS

Wood Square LFS LED is a solid wood luminaire in square shape with direct or direct / indirect illumination. The direct light is emitted through so called "dark light optics" which create a rectangular light footprint on the illumination surface. The advantage is a very high uniformity and the light is not visible from an angled view. Inside part is an acoustic absorber which is covered by natural materials like alp-hay, moss, lavender, etc

Surface treatments: Natural, oiled, antibacterial coating with silver nano-particles (flame retardant according to DIN 4102 B1)



WOOD LINEAR LED 60 TWIN ROUND LFS

Wood Linear LED Twin Round is a linear solid wood luminaire with direct illumination. The direct light is emitted through so called "dark light optics" which create a rectangular light footprint on the illumination surface. The advantage is a very high uniformity and the light is not visible from an angled view.

Surface treatments: Natural, oiled, antibacterial coating with silver nano-particles (flame retardant according to DIN 4102 B1)

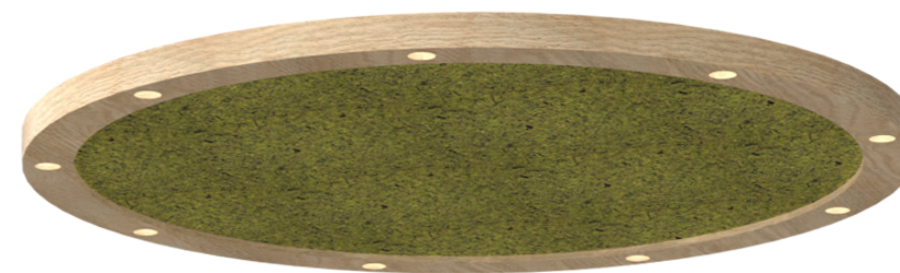

WOOD RING LED 70 - 1200 LFS

Wood Ring 1200 LFS LED is suspended luminaire in ring shape. The inside area is equipped with real natural materials like alp-hay, lavender, moss and many more. The carrier material for this natural materials is an acoustic absorber class B. The ring with integrated lenses is made of solid wood. Wood Ring LFS can be customised in different sizes and heights.

Surface treatments: Natural, oiled, antibacterial coating with silver nano-particles (flame retardant according to DIN 4102 B1)



DONUT LED 900 - 250 LFS

Donut 900 LFS LED is an extra-ordinary LED luminaire in shape of a donut with direct or direct / indirect illumination. The inside and outside layers are real natural materials like alp-hay, lavender, moss and many more. The rings are carefully milled from solid wood. The lay-in PMMA diffusor supports a very soft illumination with lambertian light characteristics. Donut LFS can be customised in different sizes and heights.

Surface treatments: Natural, oiled, antibacterial coating with silver nano-particles (flame retardant according to DIN 4102 B1)

DATASHEET

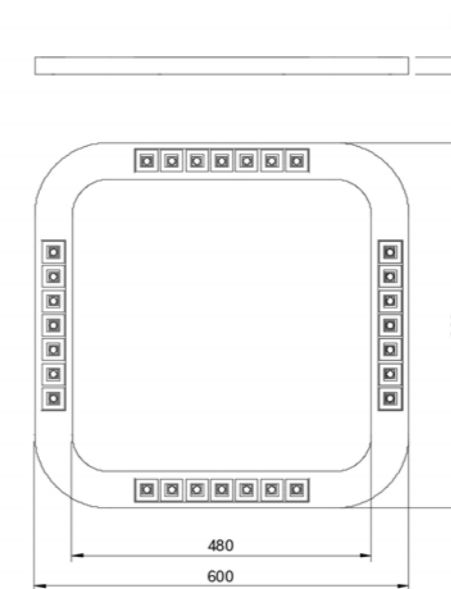
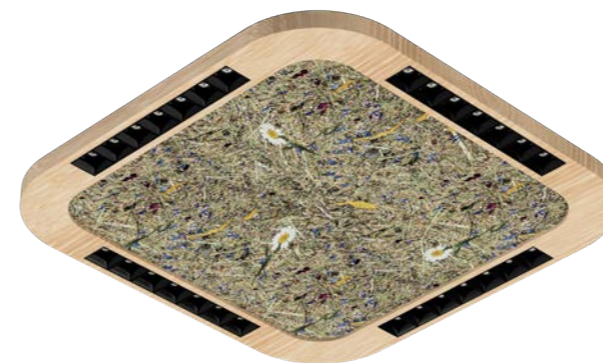

PRODUCT DATA

Size : 600 x 600 x 28 mm
 Weight : 3,2 kg
 Materials : Housing : Natural solid wood
 Optic: Polycarbonate lens + reflector
 Base plate: Aluminium
 Optic : Dark Light Reflector 80 °
 Light distribution : Direct
 Driver : FIX, DALI, Bluetooth (inside or on ceiling)
 Ambient temperature : 0 / + 35 °C
 Lifetime : L80B10 - 60 000 hours
 Installation : suspended

WOOD SQUARE LED 60 - 600
LFS

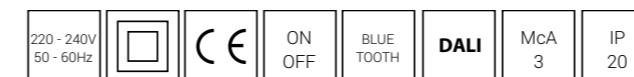

WOOD OPTIONS

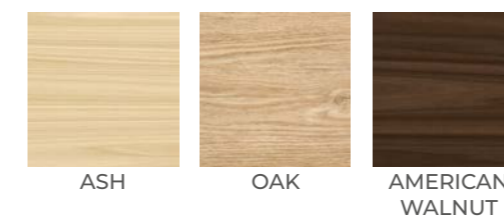

TECHNICAL SPECIFICATION

CODE	POWER	CRI	CCT	LUMEN
WS60-600LFS	27 W	> 90	3000 K	3480 lm
WS60-600LFS	27 W	> 90	4000 K	3630 lm
WS60-600LFS	28 W	> 90	TW (2700 - 6500 K)	3480 lm

Order example:

WS60-600LFS	-	Power	-	CRI / CCT	-	Beam	-	Wood	-	Driver	-	Option
WS60-600LFS	-	27	-	930	-	80	-	OAK	-	FIX	-	HAYMIX

S Q U A R E L F S



T W I N R O U N D L F S

DATASHEET

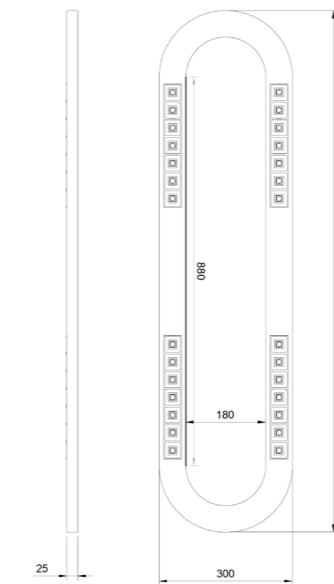

PRODUCT DATA

Size : 300 x 1180 x 25 mm
Weight : 3,8 kg
Materials : Housing : Natural solid wood
 Optic: Polycarbonate
 Base plate: Aluminium
Optic : Dark Light Reflector 80 °
Light distribution : Direct
Driver : FIX, DALI, Bluetooth (inside or on ceiling)
Ambient temperature : 0 / + 35 °C
Lifetime : L80B10 - 60 000 hours
Installation : suspended

WOOD LINEAR LED 60 TWIN ROUND LFS



WOOD OPTIONS

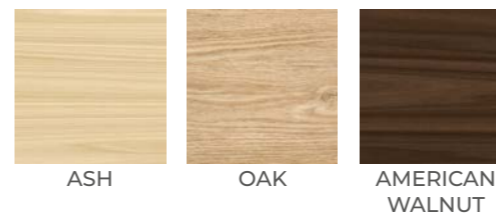

TECHNICAL SPECIFICATION

CODE	POWER	CRI	CCT	LUMEN
WL60TRLFS	27 W	> 90	3000 K	3480 lm
WL60TRLFS	27 W	> 90	4000 K	3630 lm
WL60TRLFS	28 W	> 90	TW (2700 - 6500 K)	3480 lm

Order example:

WL60TRLFS	-	Power	-	CRI / CCT	-	Beam	-	Wood	-	Driver	-	Option
WL60TRLFS	-	27	-	930	-	80	-	OAK	-	FIX	-	Almwiesn



R I N G L F S

DATASHEET

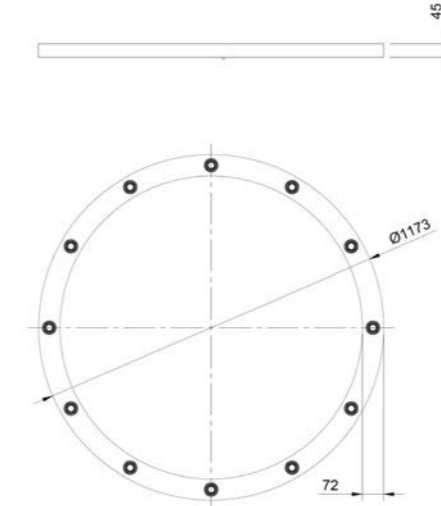

PRODUCT DATA

Size : 1173 x 1173 x 45 mm
 Weight : 11,2 kg
 Materials : Housing : Natural solid wood
 Optic: Polycarbonate
 Base plate: Aluminium
 Optic : Lens 60° and milled light chambers
 Light distribution : Direct
 Driver : FIX, DALI, Bluetooth (inside ceiling)
 Ambient temperature : 0 / + 35 °C
 Lifetime : L80B10 - 60 000 hours
 Installation : suspended

WOOD RING LED 70 - 1200 LFS

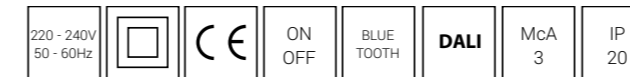

WOOD OPTIONS

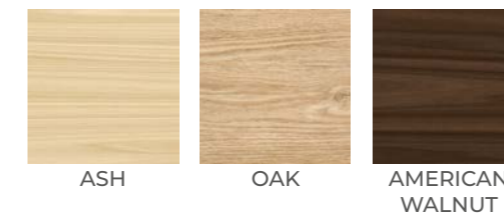

TECHNICAL SPECIFICATION

CODE	POWER	CRI	CCT	LUMEN
WRI70-1200LFS	70 W	> 90	3000 K	7800 lm
WRI70-1200LFS	70 W	> 90	4000 K	8000 lm

Order example:

WRI70-1200LFS	-	Power	-	CRI / CCT	-	Beam	-	Wood	-	Driver	-	Option
WRI70-1200LFS	-	70	-	930	-	60	-	OAK	-	FIX	-	Moss hellgr

DATASHEET



D O N U T L F S

**DONUT LED 900 x 250
LFS**



WOOD OPTIONS

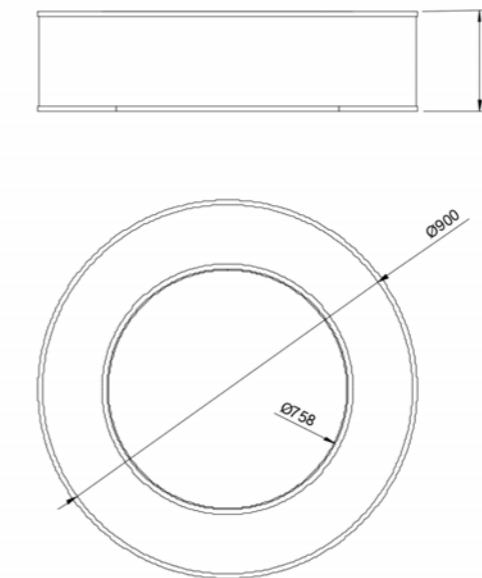
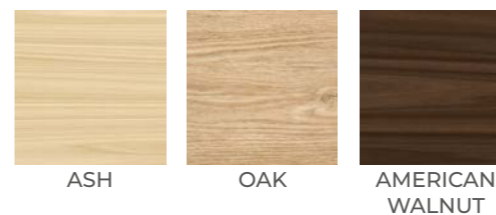

PRODUCT DATA

Size : 900 x 900 x 250 mm
 Weight : 7,6 kg
 Materials : Housing : Natural solid wood frame, decor
 Optic: PMMA
 Base plate: Aluminium
 Optic : Diffusor
 Light distribution : lambertian
 Driver : FIX, DALI, Bluetooth (build in)
 Ambient temperature : 0 / + 35 °C
 Lifetime : L80B10 - 60 000 hours
 Installation : suspended

TECHNICAL SPECIFICATION

CODE	POWER	CRI	CCT	LUMEN
DON900LFS	76 W	> 90	3000 K	6000 lm
DON900LFS	76 W	> 90	4000 K	6450 lm
DON900LFS	76 W	> 90	TW (2700 - 6500 K)	6000 lm

Order example:

DON900LFS	-	Power	-	CRI / CCT	-	Beam	-	Wood	-	Driver	-	Option
DON900LFS	-	76	-	930	-	DIFF	-	OAK	-	FIX	-	HAYMIX





W O O D P E N D A N T S



WOOD BALL LED

Handmade solid wood luminaire in ball shape with direct illumination and various beam angles from 12-60° powered by high precision lenses. The integrated chrysal heatsink provide through chimney effect best thermal management aspects.

Surface threathments: Natural, oiled, antibacterial coating with silver nano-particles (flame retardant according to DIN 4102 B1)



WOOD CONE LED

Handmade solid wood luminaire in conical shape with direct illumination and various beam angles from 12-60° powered by high precision lenses. The integrated chrysal heatsink provide through chimney effect best thermal management aspects.

Surface threathments: Natural, oiled, antibacterial coating with silver nano-particles (flame retardant according to DIN 4102 B1)



WOOD CYLINDER LED

Handmade solid wood luminaire in cylindric shape with direct illumination and various beam angles from 12-60° powered by high precision lenses. The integrated chrysal heatsink provide through chimney effect best thermal management aspects.

Surface threathments: Natural, oiled, antibacterial coating with silver nano-particles (flame retardant according to DIN 4102 B1)



WOOD BALL MINI

Wood Ball mini LED is a wood luminaire in small size ball shape with direct illumination. The wood texture around the diameter is horizontal orientated. The light emitting area is illuminated with a high color rendering, so that the wood patterns are impressively highlighted. The Wood mini series is available with baldachin or can also be installed on a 48V system.

Surface treatments: Natural, oiled, antibacterial coating with silver nanoparticles (flame retardant according to DIN 4102 B1)



WOOD CYLINDER TWIST LED 65

Wood Cylinder Twist LED 65 LED is a suspended solid wood luminaire in twisted shape with direct illumination. The wood texture around the diameter is vertical orientated and due to the design in triangle orientation. The light is emitted through a high precision lens in combination with milled light chambers. This creates an extra-ordinary look during times with low environment light. The twisted design provides as well a unique eye catch effect. In some angles you might feel that the luminaire housing is not hanging vertical which is of course just an visual interpretation.

Surface treatments: Natural, oiled, antibacterial coating with silver nanoparticles (flame retardant according to DIN 4102 B1)



WOOD CYLINDER TWIST LED 90

Wood Cylinder Twist LED 90 LED is a suspended solid wood luminaire in twisted shape with direct illumination. The wood texture is vertical orientated and due to the design in triangle orientation. The light is emitted through a high precision lens in combination with milled light chambers. The light chamber is done smooth and without steps. This creates an extra-ordinary look during times with low environment light. The twisted design provides as well a unique eye-catch effect – in some angle view you might feel that the luminaire housing is not hanging straight vertical which is of course just an visual miss-interpretation.

Surface treatments: Natural, oiled, antibacterial coating with silver nanoparticles (flame retardant according to DIN 4102 B1)

DATASHEET



B A L L

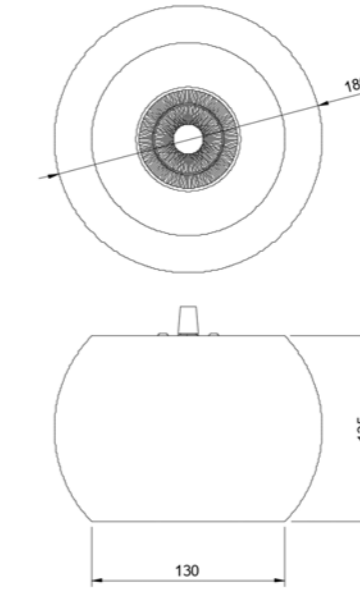

PRODUCT DATA

Size : 180 x 180 x 125
 Weight : 1,7 kg
 Materials : Housing : Natural solid wood
 Optic: Polycarbonate
 Base plate: Aluminium
 Optic : Lens 12 °, 24 °, 38 °, 60 °
 Light distribution : Direct
 Driver : FIX, DALI, Bluetooth (inside or on ceiling)
 Ambient temperature : 0 / + 35 °C
 Lifetime : L80B10 - 60 000 hours
 Installation : suspended

WOOD BALL LED

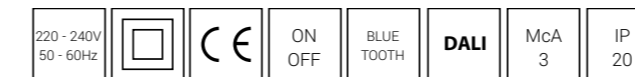

WOOD OPTIONS

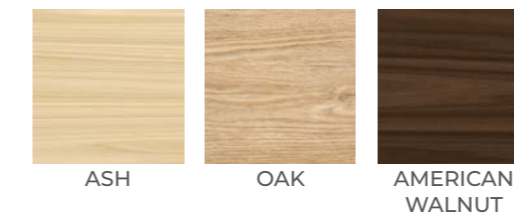

TECHNICAL SPECIFICATION

CODE	POWER	CRI	CCT	LUMEN
WB	12 W	> 90	2700 K	975 lm
WB	12 W	> 90	3000 K	1050 lm
WB	12 W	> 95	3200 K	975 lm
WB	12 W	> 90	4000 K	1150 lm

Order example:

WB	-	Power	-	CRI / CCT	-	Beam	-	Wood	-	Driver	-	Option
WB	-	12	-	930	-	60	-	OAK	-	FIX	-	XYZ



C O N E

DATASHEET

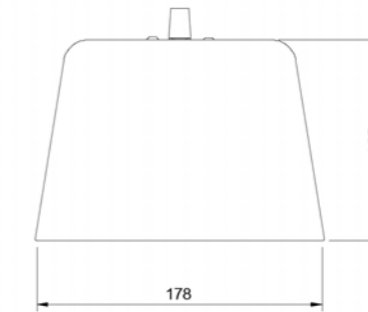
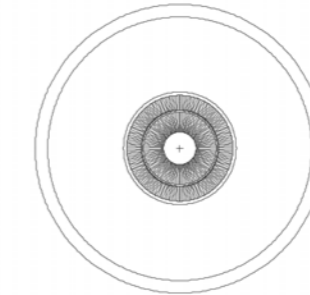

PRODUCT DATA

Size : 178 x 178 x 125 mm
 Weight : 1,3 kg
 Materials : Housing : Natural solid wood
 Reflector: Polycarbonate
 Base plate: Aluminium
 Optic : Lens 12 °, 24 °, 38 °, 60 °
 Light distribution : Direct
 Driver : FIX, DALI, Bluetooth (inside or on ceiling)
 Ambient temperature : 0 / + 35 °C
 Lifetime : L80B10 - 60 000 hours
 Installation : suspended

WOOD CONE LED

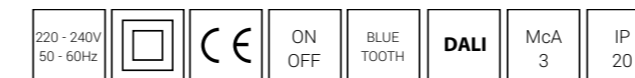

WOOD OPTIONS

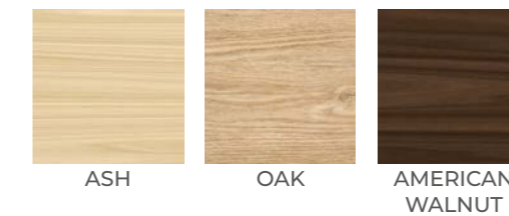

TECHNICAL SPECIFICATION

CODE	POWER	CRI	CCT	LUMEN
WCO	12 W	> 90	2700 K	975 lm
WCO	12 W	> 90	3000 K	1050 lm
WCO	12 W	> 95	3200 K	975 lm
WCO	12 W	> 90	4000 K	1150 lm

Order example:

WCO	-	Power	-	CRI / CCT	-	Beam	-	Wood	-	Driver	-	Option
WCO	-	12	-	930	-	60	-	OAK	-	FIX	-	XYZ



C Y L I N D E R

DATASHEET

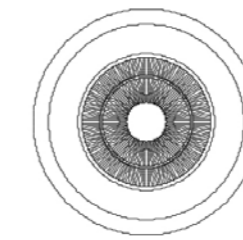

PRODUCT DATA

Size : 116 x 116 x 140 mm
 Weight : 0,9 kg
 Materials : Housing : Natural solid wood
 Reflector: Polycarbonate
 Base plate: Alluminium
 Optic : Lens 12 °, 24 °, 38 °, 60 °
 Light distribution : Direct
 Driver : FIX, DALI, Bluetooth (inside or on ceiling)
 Ambient temperature : 0 / + 35 °C
 Lifetime : L80B10 - 60 000 hours
 Installation : suspended

WOOD CYLINDER LED

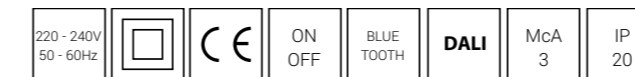

WOOD OPTIONS

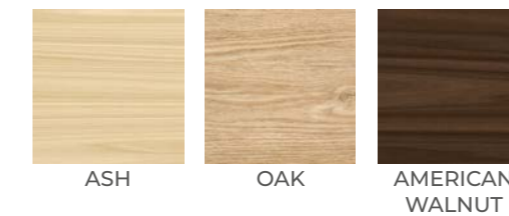

TECHNICAL SPECIFICATION

CODE	POWER	CRI	CCT	LUMEN
WCY	12 W	> 90	2700 K	975 lm
WCY	12 W	> 90	3000 K	1050 lm
WCY	12 W	> 95	3200 K	975 lm
WCY	12 W	> 90	4000 K	1150 lm

Order example:

WCY	-	Power	-	CRI / CCT	-	Beam	-	Wood	-	Driver	-	Option
WCY	-	12	-	930	-	60	-	OAK	-	FIX	-	XYZ



B A L L M I N I

DATASHEET

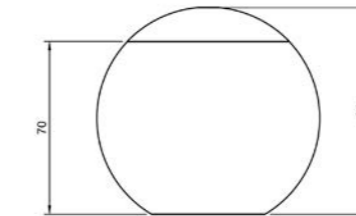
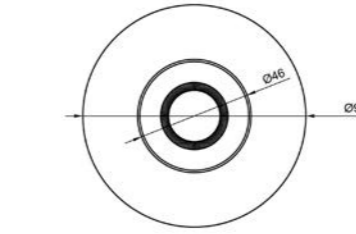

PRODUCT DATA

Size : 90 x 90 x 90
 Weight : 0,7 kg
 Materials : Housing : Natural solid wood
 Optic: Polycarbonate
 Base plate: Aluminium
 Optic : Lens 12 °, 24 °, 38 °, 60 °
 Light distribution : Direct
 Driver : FIX, DALI, Bluetooth (inside or on ceiling)
 Ambient temperature : 0 / + 35 °C
 Lifetime : L80B10 - 60 000 hours
 Installation : suspended

WOOD BALL MINI LED

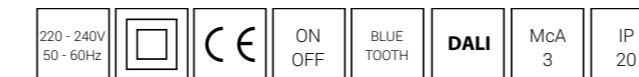

WOOD OPTIONS

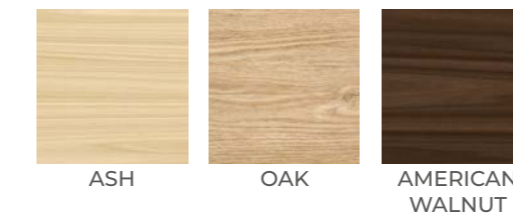

TECHNICAL SPECIFICATION

CODE	POWER	CRI	CCT	LUMEN
WB	5 W	> 90	2700 K	425 lm
WB	5 W	> 90	3000 K	450 lm

Order example:

WB90	-	Power	-	CRI / CCT	-	Beam	-	Wood	-	Driver	-	Option
WB90	-	5	-	930	-	60	-	OAK	-	FIX	-	XYZ



C Y L I N D E R T W I S T 6 5

DATASHEET

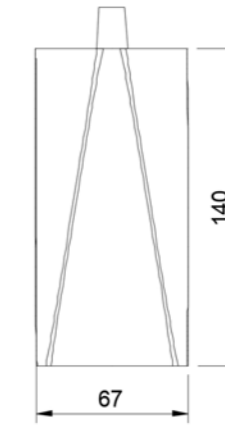
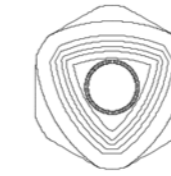

PRODUCT DATA

Size : 67 x 67 x 140 mm
Weight : 0,7 kg
Materials : Housing : Natural solid wood
 Optic: Polycarbonate
 Base plate: Aluminium
Optic :High precision Lens 38 °, 45 °and milled light chambers
Light distribution : Direct
Driver : FIX (on/off), DALI, BT (Casambi bluetooth)
Ambient temperature : 0 / + 35 °C
Lifetime : L80B10 - 60 000 hours
Installation : suspended
Surface treatment : Natural, oiled, fire proof coating, anti-bacterial coating

WOOD CYLINDER TWIST LED 65

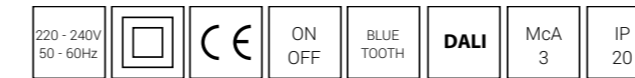

WOOD OPTIONS

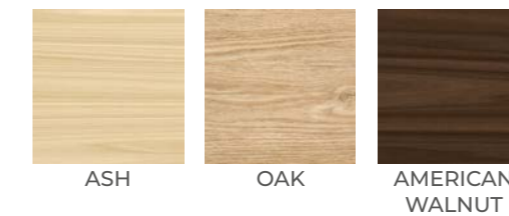

TECHNICAL SPECIFICATION

CODE	POWER	CRI	CCT	LUMEN
WCYTW65	6 W	> 90	3000 K	525 lm
WCYTW65	6 W	> 90	4000 K	575 lm

Order example:

WCYTW65	-	Power	-	CRI / CCT	-	Beam	-	Wood	-	Driver	-	Option
WCYTW65	-	6	-	930	-	38	-	OAK	-	FIX	-	XYZ

DATASHEET

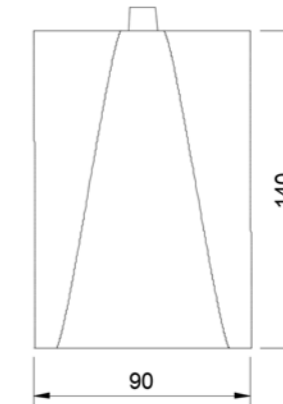
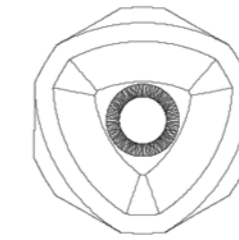

PRODUCT DATA

Size : 90 x 90 x 140 mm
 Weight : 0,9 kg
 Materials : Housing : Natural solid wood
 Optic: Polycarbonate
 Base plate: Alluminium
 Optic :High precision Lens 38 °, 60 °and milled light chambers
 Light distribution : Direct
 Driver : FIX (on/off), DALI, BT (Casambi bluetooth)
 Ambient temperature : 0 / + 35 °C
 Lifetime : L80B10 - 60 000 hours
 Installation : suspended
 Surface treatment : Natural, oiled, fire proof coating, anti-bacterial coating

**WOOD CYLINDER TWIST
LED 90**

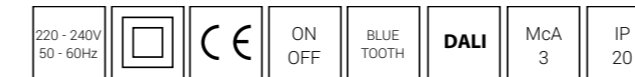

WOOD OPTIONS

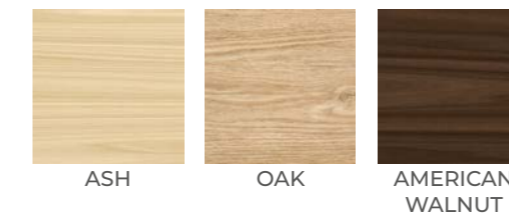

TECHNICAL SPECIFICATION

CODE	POWER	CRI	CCT	LUMEN
WCYTW90	12 W	> 90	3000 K	1050 lm
WCYTW90	12 W	> 90	4000 K	1150 lm

Order example:

WCYTW90	-	Power	-	CRI / CCT	-	Beam	-	Wood	-	Driver	-	Option
WCYTW90	-	12	-	920	-	60	-	OAK	-	FIX	-	XYZ

C Y L I N D E R T W I S T 9 0



D O W N L I G H T S P U R E



WOOD DOWNLIGHT SQUARE LED 120

Wood Downlight Square LED 120 is a square solid downlight. The illumination is direct through a high precision lens and milled light chamber. The illumination pattern is square for highest uniformity levels. The milled light chamber creates an impressive illuminated wood texture especially in times with low environment light and converts the downlight to an design element in the space.

Surface treatments: Natural, oiled, antibacterial coating with silver nano-particles (flame retardant according to DIN 4102 B1)



WOOD DOWNLIGHT ROUND LED 80

Wood Downlight Round LED 80 is a round solid wood downlight. The illumination is direct through a high precision lens and milled light chamber. The milled light chamber creates an impressive illuminated wood texture especially in times with low environment light and converts the downlight to an design element in the space.

Surface treatments: Natural, oiled, antibacterial coating with silver nano-particles (flame retardant according to DIN 4102 B1)



WOOD DOWNLIGHT ROUND LED 130

Wood Downlight Round LED 130 is a round solid wood downlight. The illumination is direct through a high precision lens and milled light chamber. The milled light chamber creates an impressive illuminated wood texture especially in times with low environment light and converts the downlight to an design element in the space.

Surface treatments: Natural, oiled, antibacterial coating with silver nano-particles (flame retardant according to DIN 4102 B1)

DATASHEET



D O W N L I G H T S Q U A R E 1 2 0

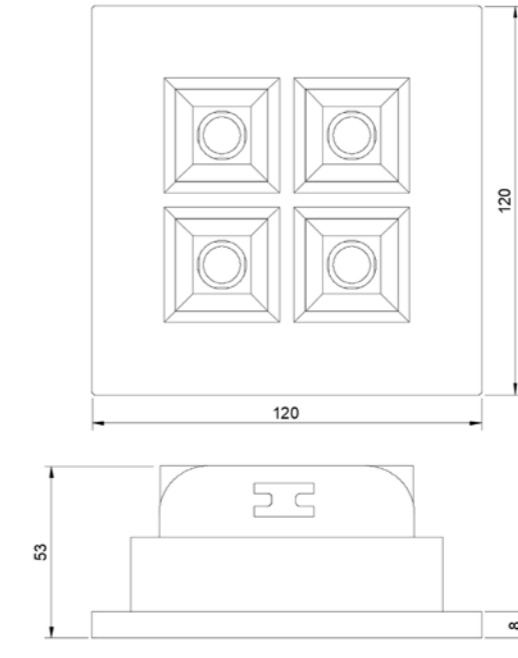
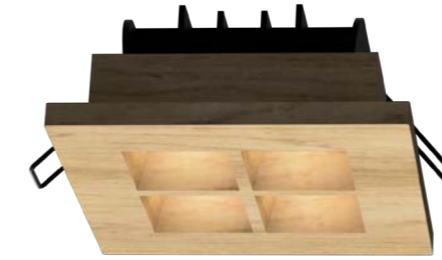

PRODUCT DATA

Size : 120 x 120 x 53 mm
 Weight : 0,5 kg
 Materials : Housing : Natural solid wood
 Optic: Polycarbonate
 Base plate: black powder coated
 aluminium heatsink
 Optic : High precision lens and milled light
 chambers 80 °
 Light distribution : Direct
 Driver : FIX (on/off), DALI, BT (Casambi bluetooth)
 Driver placement : inside the ceiling
 Ambient temperature : 0 / + 35 °C
 Lifetime : L80B10 - 60 000 hours
 Installation : ceiling recessed
 Surface treatment : Natural, oiled, fire proof coating,
 anti-bacterial coating
 Ceiling cutout : 105x105 mm

WOOD DOWNLIGHT SQUARE
LED 120

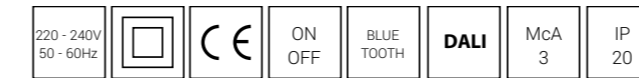

WOOD OPTIONS

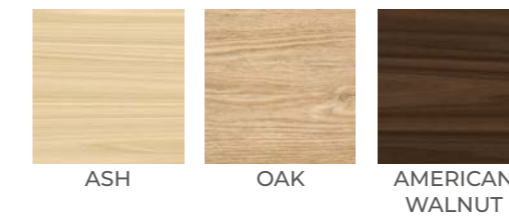

TECHNICAL SPECIFICATION

CODE	POWER	CRI	CCT	LUMEN
WSD120P	8 W	> 90	3000 K	720 lm
WSD120P	8 W	> 92	4000 K	750 lm

Order example:

WSD120P	-	Power	-	CRI / CCT	-	Beam	-	Wood	-	Driver	-	Option
WSD120P	-	8	-	920	-	80	-	OAK	-	FIX	-	XYZ

DATASHEET



D O W N L I G H T R O U N D 8 0

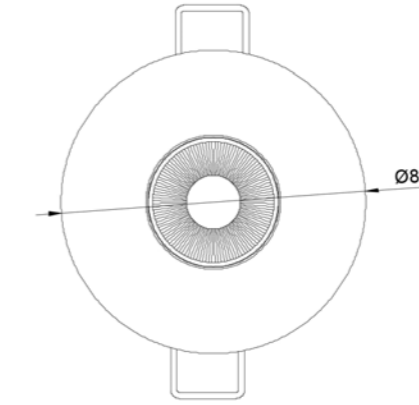
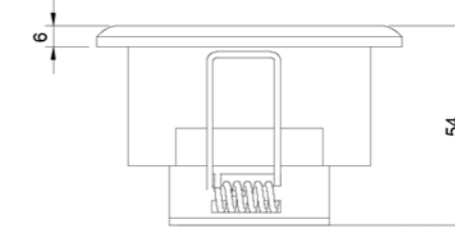

PRODUCT DATA

Size : 81 x 81 x 54 mm
 Weight : 0,4 kg
 Materials : Housing : Natural solid wood
 Optic: Polycarbonate
 Base plate: Aluminium, black powder coated heatsink
 Optic : High precision Lens 38 °, 45 °and milled light chambers
 Light distribution : Direct
 Driver : FIX (on/off), DALI, BT (Casambi bluetooth)
 Driver placement : inside the ceiling
 Ambient temperature : 0 / + 35 °C
 Lifetime : L80B10 - 60 000 hours
 Installation : ceiling recessed
 Surface treatment : Natural, oiled, fire proof coating, anti-bacterial coating
 Ceiling cutout : 68 mm

WOOD DOWNLIGHT ROUND
LED 80

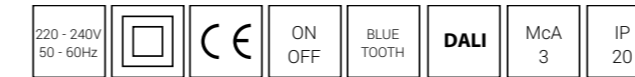

WOOD OPTIONS

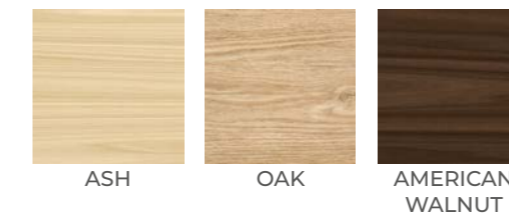

TECHNICAL SPECIFICATION

CODE	POWER	CRI	CCT	LUMEN
WRD80P	5 W	> 90	3000 K	450 lm
WRD80P	5 W	> 90	4000 K	470 lm

Order example:

WRD80P	-	Power	-	CRI / CCT	-	Beam	-	Wood	-	Driver	-	Option
WRD80P	-	5	-	930	-	38	-	OAK	-	FIX	-	XYZ



D O W N L I G H T R O U N D 1 3 0

DATASHEET

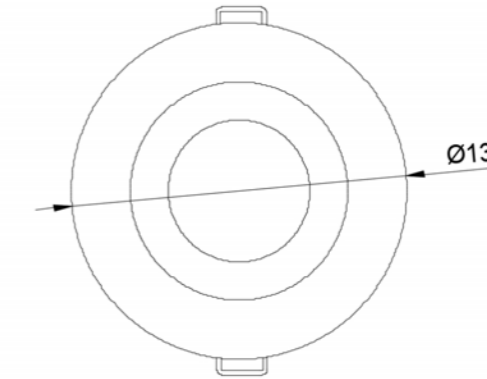
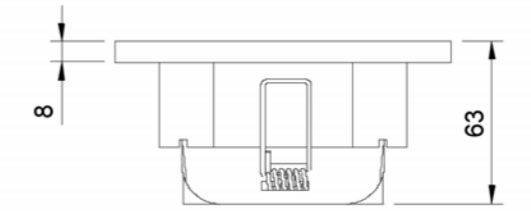

PRODUCT DATA

Size : 130 x 130 x 63 mm
 Weight : 0,5 kg
 Materials : Housing : Natural solid wood
 Optic: Polycarbonate
 Base plate: Aluminium, black powder coated heatsink
 Optic : High precision Lens 38 °, 60 °and milled light chambers
 Light distribution : Direct
 Driver : FIX (on/off), DALI, BT (Casambi bluetooth)
 Driver placement : inside the ceiling
 Ambient temperature : 0 / + 35 °C
 Lifetime : L80B10 - 60 000 hours
 Installation : ceiling recessed
 Surface treatment : Natural, oiled, fire proof coating, anti-bacterial coating
 Ceiling cutout : 115 mm

WOOD DOWNLIGHT ROUND LED 130

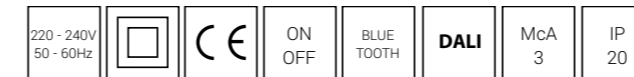

WOOD OPTIONS

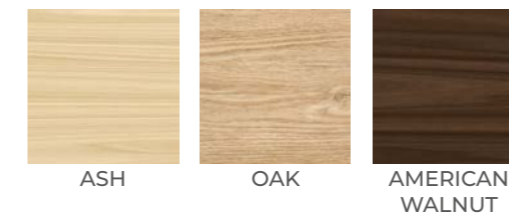

TECHNICAL SPECIFICATION

CODE	POWER	CRI	CCT	LUMEN
WRD130P	8 W	> 90	2700 K	720 lm
WRD130P	8 W	> 90	3000 K	750 lm

Order example:

WRD130P	-	Power	-	CRI / CCT	-	Beam	-	Wood	-	Driver	-	Option
WRD130P	-	8	-	920	-	60	-	OAK	-	FIX	-	XYZ





WOOD CARDANIC SPOT

Wood Cardanic Spot is a cardanic downlight based on shielded lens technology. The thermal management is solved by a high performance pressed aluminium heatsink which performs 40% better than traditional thermal solutions. Beam angles from 12-60° make this luminaire with solid wood frame an allrounder for many applications.

Surface treatments: Natural, oiled, antibacterial coating with silver nano-particles (flame retardant according to DIN 4102 B1)



WOOD CARDANIC TWIN SPOT

Wood Cardanic Twn Spot is a cardanic downlight based on shielded lens technology and 2 luminaire heads. The thermal management is solved by a high performance pressed aluminium heatsink which performs 40% better than traditional thermal solutions. Beam angles from 12-60° make this luminaire with solid wood frame an allrounder for many applications.

Surface treatments: Natural, oiled, antibacterial coating with silver nano-particles (flame retardant according to DIN 4102 B1)



WOOD LINEAR DOWNLIGHT 190

Wood Linear 190 is a compact downlight with dark light reflectors. The length can be customized.

Surface treatments: Natural, oiled, antibacterial coating with silver nano-particles (flame retardant according to DIN 4102 B1)



WOOD WALL LED 115 DECORE

Wood Wall LED 115 Decore is a wall mounted up & down luminaire made of aluminium. The front ring (light chamber) is manufactured of solid wood and available in different wood types. The up and down illumination can be separately controlled.

Surface treatments: Natural, oiled, antibacterial coating with silver nano-particles (flame retardant according to DIN 4102 B1)



CLASSIC ROUND LED 440 DECORE

Classic Round 440 Decore is a round luminaire with direct and indirect illumination (aura effect). The classic round luminaire has a wood front frame and the diffuser is recessed. The housing is made of powder coated aluminium. Benefit of various customisation possibilities in colors and dimensions.

Surface treatments: Natural, oiled, antibacterial coating with silver nano-particles (flame retardant according to DIN 4102 B1)





C A R D A N I C

DATASHEET



WOOD CARDANIC SPOT



WOOD OPTIONS



PRODUCT DATA

Size : 185 x 185 x 85 mm
 Weight : 1,2 kg
 Materials : Frame : Natural solid wood
 Reflector: Polycarbonate
 Luminaire head: Aluminium
 Housing: Metal
 Optic : Shielded lens 12°, 24°, 38°, 55°
 Light distribution : Direct
 Driver : FIX, DALI, Bluetooth (inside ceiling)
 Ambient temperature : 0 / + 35 °C
 Lifetime : L80B10 - 60 000 hours
 Installation : ceiling recessed
 Ceiling cutout : 165 x 165 mm

TECHNICAL SPECIFICATION

CODE	POWER	CRI	CCT	LUMEN
WCS	16 W	> 90	2700 K	1300 lm
WCS	16 W	> 90	3000 K	1400 lm
WCS	16 W	> 95	3200 K	1300 lm
WCS	16 W	> 90	4000 K	1600 lm
WCS	28 W	> 95	2700 K	2200 lm
WCS	28 W	> 90	3000 K	2400 lm
WCS	28 W	> 95	3200 K	2200 lm
WCS	28 W	> 90	4000 K	2700 lm

Order example:

WCS	-	Power	-	CRI / CCT	-	Beam	-	Wood	-	Driver	-	Option
WCS	-	16	-	930	-	55	-	OAK	-	FIX	-	XYZ

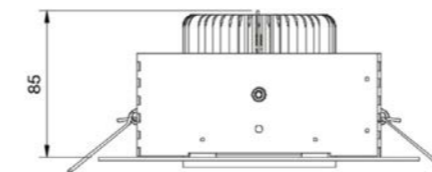
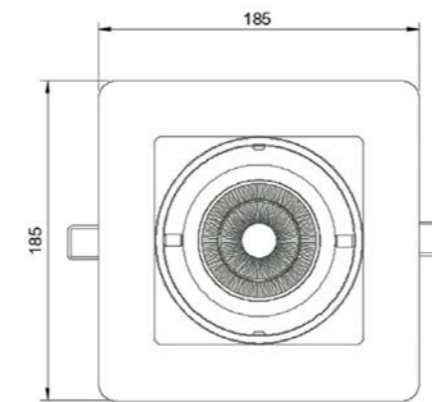

DATASHEET



C A R D A N I C T W I N



WOOD CARDANIC TWIN SPOT

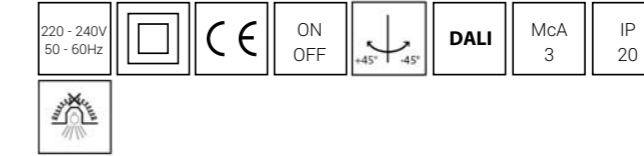

WOOD OPTIONS

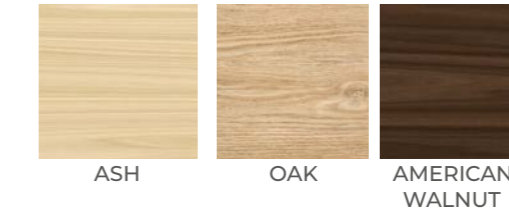

PRODUCT DATA

Size : 360 x 185 x 65 mm
 Weight : 2,4 kg
 Materials : Frame : Natural solid wood
 Optic: Polycarbonate
 Luminaire head: Aluminium
 Optic : Shielded lens 12°, 24°, 38°, 55°
 Light distribution : Direct
 Driver : FIX, DALI, Bluetooth (inside ceiling)
 Ambient temperature : 0 / + 35 °C
 Lifetime : L80B10 - 60 000 hours
 Installation : ceiling recessed
 Ceiling cutout : 340 x 165 mm

TECHNICAL SPECIFICATION

CODE	POWER	CRI	CCT	LUMEN
WCTS	2 x 16 W	> 90	2700 K	1300 lm
WCTS	2 x 16 W	> 90	3000 K	1400 lm
WCTS	2 x 16 W	> 95	3200 K	1300 lm
WCTS	2 x 16 W	> 90	4000 K	1600 lm
WCTS	2 x 28 W	> 95	2700 K	2200 lm
WCTS	2 x 28 W	> 90	3000 K	2400 lm
WCTS	2 x 28 W	> 95	3200 K	2200 lm
WCTS	2 x 28 W	> 90	4000 K	2700 lm

Order example:

WCS	-	Power	-	CRI / CCT	-	Beam	-	Wood	-	Driver	-	Option
WCTS	-	16	-	930	-	55	-	OAK	-	FIX	-	XYZ

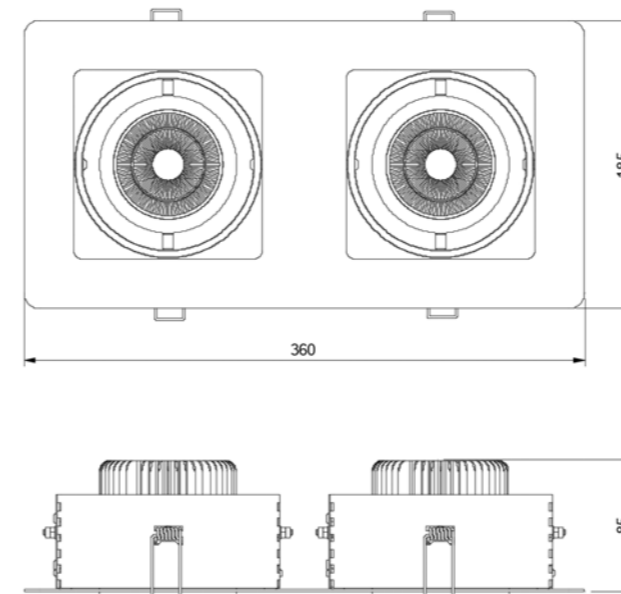



LINEAR DOWNLIGHT

DATASHEET

WOOD LINEAR DOWNLIGHT 190

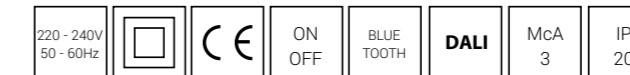

WOOD OPTIONS



PRODUCT DATA

Size : 199 x 70 x 40 mm
 Weight : 0,8 kg
 Materials : Frame : Natural solid wood
 Reflector: Polycarbonate
 Luminaire head: Aluminium
 Optic : Lens 80 °
 Light distribution : Direct
 Driver : FIX, DALI, Bluetooth (inside ceiling)
 Ambient temperature : 0 / + 35 °C
 Lifetime : L80B10 - 60 000 hours
 Installation : ceiling recessed
 Ceiling cutout : 60 x 190 mm

TECHNICAL SPECIFICATION

CODE	POWER	CRI	CCT	LUMEN
WLD190	6 W	> 90	3000 K	660 lm
WLD190	6 W	> 90	4000 K	690 lm
WLD190	6 W	> 90	2700 - 6500 K	630 lm

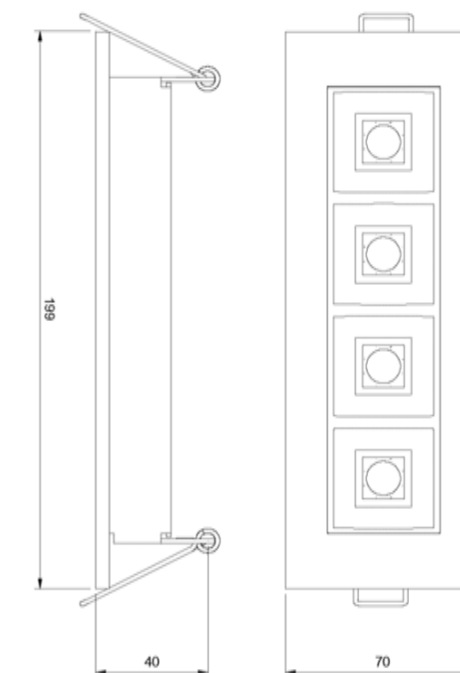

Order example:

WLD190	-	Power	-	CRI / CCT	-	Beam	-	Wood	-	Driver	-	Option
WLD190	-	6	-	930	-	80	-	OAK	-	FIX	-	XYZ



W A L L 1 1 5 D E C O R E

DATASHEET



CLASSIC WALL LED 115 DECORE



WOOD OPTIONS

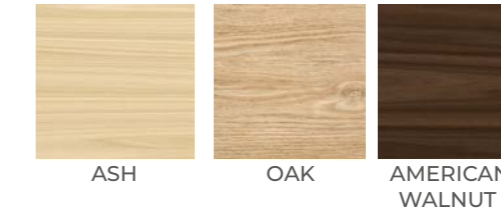

COLOR OPTIONS

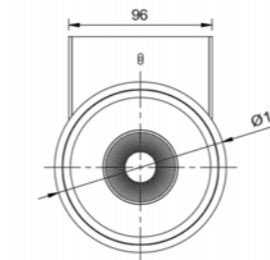
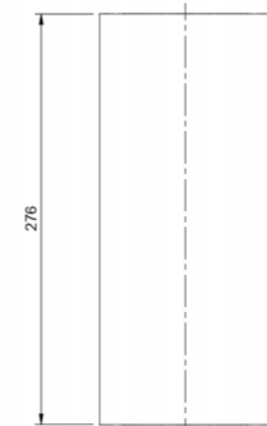

PRODUCT DATA

Size : 115 x 276 mm
 Weight : 1,2 kg
 Materials : Housing : Aluminium
 Optic: Polycarbonate lens
 Base plate: Aluminium
 Optic : Lens 12°, 38° and milled light chambers
 Light distribution : Direct / Indirect
 Driver : FIX, DALI
 Ambient temperature : 0 / + 35 °C
 Lifetime : L80B10 - 60 000 hours
 Installation : wall mounted
 IP rating : IP20

TECHNICAL SPECIFICATION

CODE	POWER	CRI	CCT	LUMEN
CW115	2x12 W	> 90	3000 K	2x1110 lm
CW115	2x12 W	> 90	4000K	2x1150 lm

Order example:

CW115	-	Power	-	CRI / CCT	-	Beam	-	Color	-	Driver	-	Option
CW115	-	2x12	-	930	-	2x12	-	9003	-	FIX	-	OAK



R O U N D 4 4 0 D E C O R E

DATASHEET

CLASSIC ROUND LED 440 DECORE

PRODUCT DATA

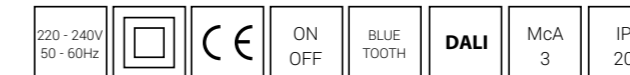

Size : 440x80mm
 Weight : 3,5 kg
 Materials : Housing : Aluminium
 Optic: Polycarbonate
 Color: graphit, black, white
 Optic : Diffuse (DIFF) or Microprisma (MICRO)
 Light distribution : Direct / Aura
 Driver : FIX, DALI, Bluetooth (inside luminaire)
 Ambient temperature : -20 / + 35 °C
 Lifetime : L90B10 - 60 000 hours
 Installation : surface mounted with twist lock - SM
 suspended (ropes, poles) - SUS
 IP rating : IP20

WOOD OPTIONS

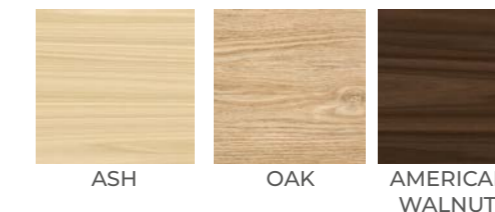

COLOR OPTIONS

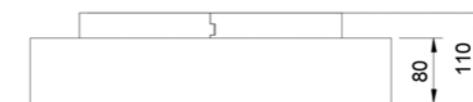
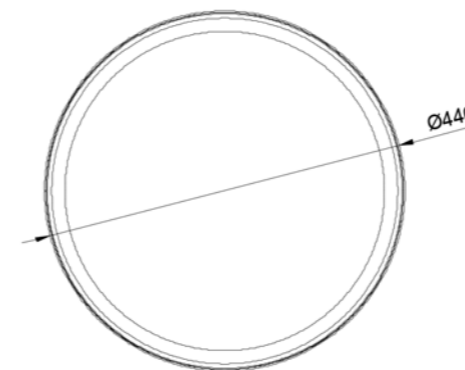

TECHNICAL SPECIFICATION

CODE	POWER	CRI	CCT	LUMEN
CRD440SM	35 W	> 90	3000 K	3380 lm
CRD440SM	35 W	> 90	4000 K	3520 lm
CRD440SM	35 W	> 90	2700 - 6500 K	3380 lm

Order example:

CRD440SM	-	Power	-	CRI / CCT	-	Beam	-	Color	-	Driver	-	Mounting
CRD440SM	-	35	-	930	-	DIFF	-	ASH	-	DALI	-	SM

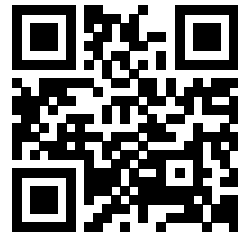

seTup.lighting
VISIBLE EMOTIONS

2022 - 2023

www.setup.lighting

+421 917 684 366
office@setup.lighting
Astrová 623/1
SK - 900 43 Kalinkovo